





English

User Manual | **UPSI-2412DPx**

UPS SYSTEM  
DIN-RAIL



## Legend of used symbols

Symbol	Description
	Attention! Important hazard warning.
	Do not dispose of in the domestic waste.
	Warning of electrical voltage.

## Revision Directory

Date	Change
25.02.2021 Revision 0-1	Initial version
31.03.2021 Revision 1	Release version
17.10.2021 Revision 1-1	F14 Shutdown diagram added
15.02.2022 Revision 1-2	Chapter B3 included
08.03.2022 Revision 1-3	Corrections made, BS updated

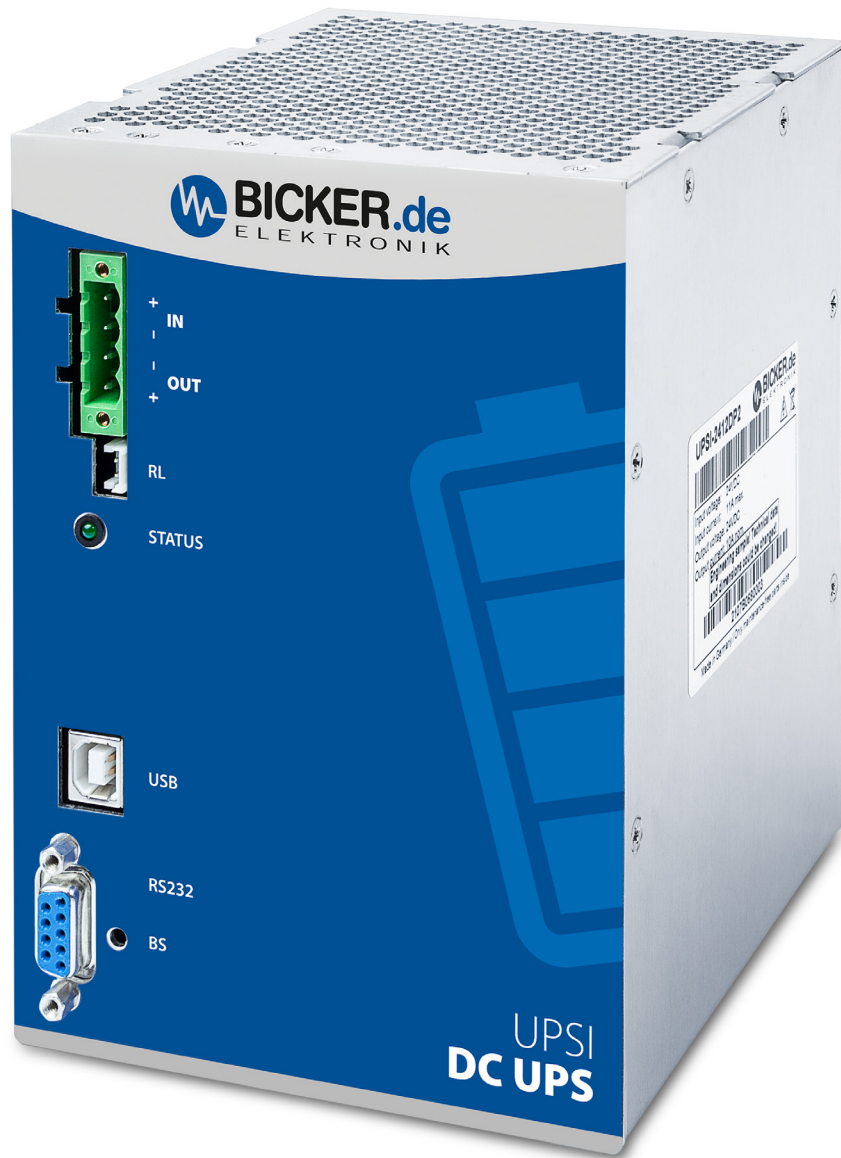

## A Brief specification

### UPSI-2412DP2 / -DP3

24 VDC / 10 A

- ✓ **Powerful 24 VDC UPS (DIN rail version)**
- ✓ **Integrated maintenance-free Supercaps (DP2) OR LiFePO4 battery (DP3)**
- ✓ **Up to 500 000 cycles (DP2) | up to 5 000 cycles (DP3)**
- ✓ **Capacity DP2: 13.5 kJ | DP3: 64 Wh**
- ✓ **Intelligent input current detection**
- ✓ **Regulated output voltage in battery mode**
- ✓ **Minimum load detection**
- ✓ **Power-fail timer function**
- ✓ **Relay dry contact on power fail**
- ✓ **Reboot function**
- ✓ **Fuel gauge**
- ✓ **Shutdown via external signal**
- ✓ **UPSI-2412DP3 with additional Battery start function**



### Technical Data

Input voltage	24 VDC (22.8...30 V)
Input current	11 A max.
Output voltage	Normal mode: $V_{IN} - 0.6$ VDC max. (depending on load) Battery mode: 23.5 VDC
Output current	10 A / 10.3...12 A for max. 10s
Capacitive load	10 000 $\mu$ F (at start / 0 A output load)
Charging method	CC/CV/CP
Protection	Overcurrent protection at output, Short circuit protection at output
Interface	USB, RS232, HID UPS
Battery technology	DP2: EDLC 13.5 kJ (9.0 kJ useful) / 3.75 Wh (2.5 Wh useful) DP3: LiFePO4 2.5 Ah / 64 Wh
Ambient temperature	Operating                      Storage/Transport DP2: -20...+70 °C      DP2: -30...+70 °C DP3: -20...+55 °C      DP3: -30...+55 °C, recommended state of charge 80%
Operating altitude	$\leq$ 4000 m
Max. permitted humidity	$\leq$ 95 % (at +25 °C, no dew)
Dimensions W / H / D	111 x 157 x 131 mm (without front connectors and DIN-Rail mounting bracket)
Weight	1.72 kg (DP2), 1.53 kg (DP3)

**Backup time\* UPSI-2412DP2**

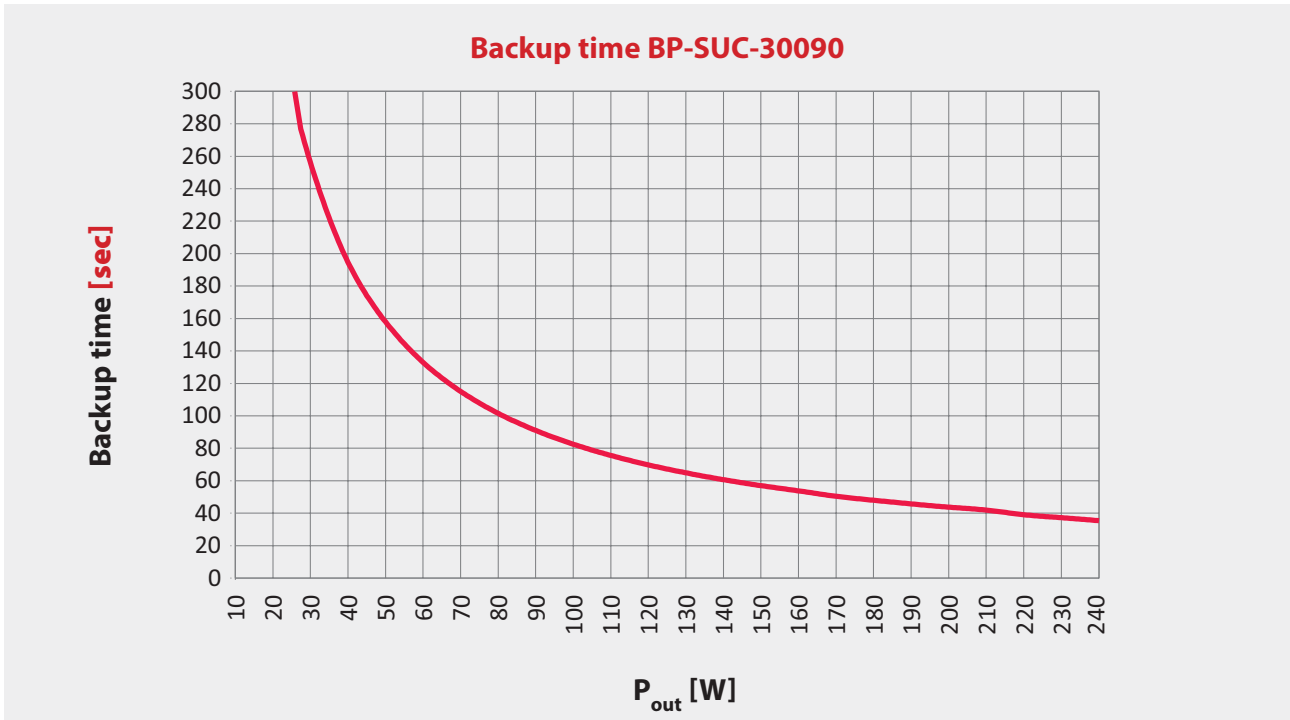

**Backup time\* UPSI-2412DP3**

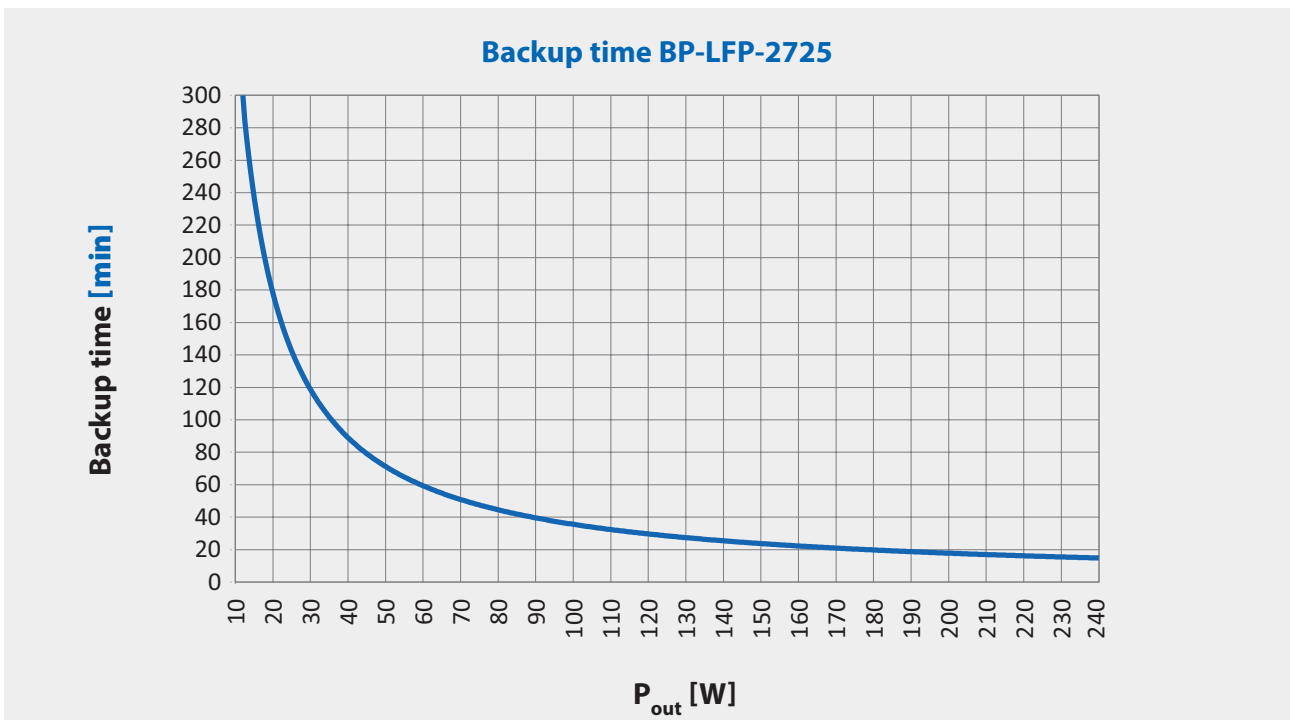

\*Backup time depends on battery capacitance, load and temperature. At very high or low temperatures a reduction of backup time occurs. Unless otherwise specified, the values apply to measurements at +25 °C

<b>A</b>	<b>Brief specification UPSI-2412DP2 / UPSI-2412DP3 .....</b>	<b>4</b>
<b>B</b>	<b>Introduction and description .....</b>	<b>7</b>
B1	Description of the product and its functions .....	7
B2	Intended use .....	8
B3	UPS Gen2 Configuration Software.....	8
<b>C</b>	<b>Safety instructions .....</b>	<b>9</b>
<b>D</b>	<b>Technical Data .....</b>	<b>10</b>
D1	General Technical Data.....	10
D2	Drawing.....	18
<b>E</b>	<b>Name / Address / Support E-Mail / Phone number of the manufacturer .....</b>	<b>18</b>
<b>F</b>	<b>General Data .....</b>	<b>19</b>
F1	Assembly and installation advice .....	19
F2	Convection and installation position .....	19
F3	Description of connectors.....	21
F4	Dimensioning the upstream power supply.....	22
F5	Connecting diagram.....	23
F6	Initial operation .....	24
F7	Overview connector / Counterpart with description / Scope of delivery.....	25
F8	Charging time .....	25
F9	Reverse polarity / Overcurrent / Short circuit.....	25
F10	Backup time in battery mode .....	26
F11	Behaviour in case of exceeding maximum backup time.....	26
F12	Battery start (only with UPSI-2412DP3).....	26
F13	Status LED.....	27
F14	Shutdown diagram.....	28
F14	Recommendations for a long UPS service life.....	29
F15	Maintenance .....	29
F16	Disposal.....	29
F17	Disclaimer .....	29
F18	Preventive measures and rules when operating the UPS system.....	30

## B Introduction and description

### Read carefully before initial operation !

This manual shall help the user to get familiar with the product and its components and features. It shall provide information as accurately and completely as possible.

The manual as well as all documents has to be read and followed strictly before installation. Otherwise in certain situations warranty and guarantee can be cancelled partly or completely. Any liability on the part of Bicker Elektronik is excluded for possible existing errors as well as non-compliance with the instructions for use and installation.

## B1 Description of the product and its functions

The UPSI-2412DP2 and UPSI-2412DP3 (hereinafter also called UPS) are DC/DC UPS systems with numerous digital features and high performance. Die UPS combines the UPSI-2412 with an integrated energy storage: The UPSI-2412DP2 uses an energy storage with supercap (also EDLCs) technology. The UPSI-2412DP3 uses an energy storage with LiFePO4 technology. The primary use of the UPS is to secure the supply during power failures and/or voltage fluctuations. The application which should be protected is connected to the output of the UPS.

The UPS requires a rated dimensioned power supply of 24VDC at the input. After the input voltage is applied, the UPS works in normal mode automatically. The input voltage is passed through to the output and the integrated energy storage device is charged simultaneously. The charging current depends dynamically on the load current at the UPS output. The green status LED lights up continuously when the UPS is in this state.

In the event of a voltage drop or a voltage fluctuation of the input voltage (below undervoltage limit), the UPS is switched to battery mode (also backup mode). In this state, the application at the UPS output is supplied via the energy storage device. The backup time (also buffer time) depends on the used energy storage, the value of the output current and the software settings of the UPS. An important feature is that the output voltage in battery mode is always regulated to 23.5VDC and does not decrease as the voltage of the energy storage device drops. If the UPS operates in battery mode, the status LED is slowly flashing (1 Hz flashing). When the UPSI-2412DP3 (with LiFePO4 battery) is used and it is discharged completely in battery mode, the recharging has to happen as soon as possible.

When the input voltage returns, the UPS is automatically switched back to normal mode and charging of the energy storage device is continued.

The UPS can also be used for user-initiated shutdowns of the supply voltage or cycles. Application examples are the replacement of larger batteries in vehicles in which the electronics should continue to be supplied, the opening and closing of safety valves after a malfunction or the shutdown of a system.

## B2 Intended use

This device is designed to be installed into a suitable enclosure which protects against electrical, water and fire hazards and can then be used indoors and outdoors. It is primary built for being mounted on a DIN Rail and is intended for professional use in applications such as industrial control, communication and measurement technology. It must not be used in devices or equipment where a malfunction will cause serious injury or endanger human life.

## B3 UPS Gen<sup>2</sup> Configuration Software

UPS Gen<sup>2</sup> Configuration Software is required for setting parameters and programming new firmware for all UPSI Gen<sup>2</sup> devices under Microsoft® Windows. The software tool also shows the operating status of the UPS and its energy storage devices and can be connected to the device via USB:

The model has the native UPS device group integrated via USB / HID-UPS (HID Power Class). Most operating systems (OS) recognize the UPSI models via Plug & Play without additional driver and can be used with the operating system's own energy settings.

The UPS Gen<sup>2</sup> software tool offers additional setting options such as time-bound shutdown and other important features.

**The Software can be downloaded here**

**The User Manual for the Software can be downloaded here**

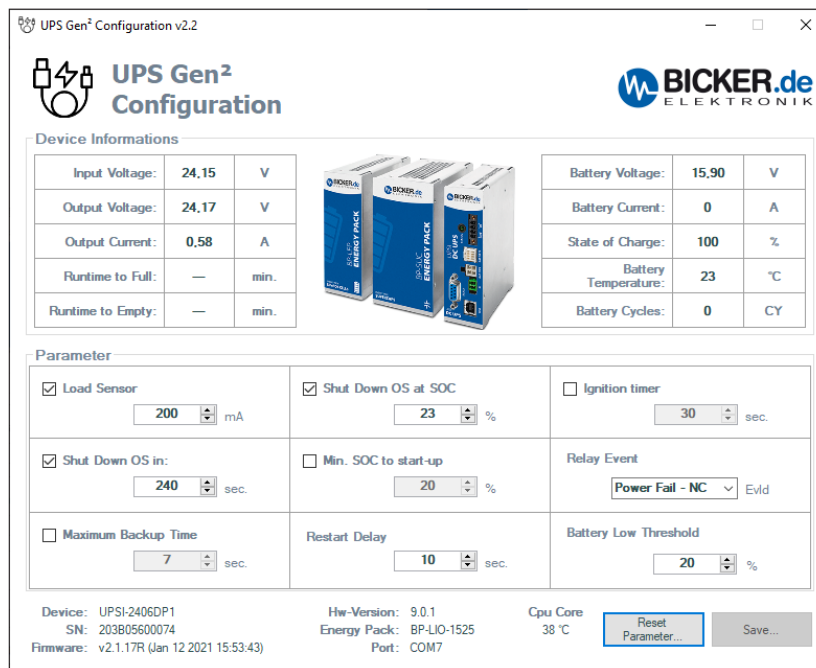

**Device Informations**

Input Voltage:	24.15	V
Output Voltage:	24.17	V
Output Current:	0.58	A
Runtime to Full:	—	min.
Runtime to Empty:	—	min.

Battery Voltage:	15.90	V
Battery Current:	0	A
State of Charge:	100	%
Battery Temperature:	23	°C
Battery Cycles:	0	CY

**Parameter**

<input checked="" type="checkbox"/> Load Sensor 200 mA	<input checked="" type="checkbox"/> Shut Down OS at SOC 23 %	<input type="checkbox"/> Ignition timer 30 sec.
<input checked="" type="checkbox"/> Shut Down OS in: 240 sec.	<input type="checkbox"/> Min. SOC to start-up 20 %	Relay Event Power Fail - NC Evid
<input type="checkbox"/> Maximum Backup Time 7 sec.	Restart Delay 10 sec.	Battery Low Threshold 20 %

Device: UPSI-2406DP1  
SN: 203805600074  
Firmware: v2.1.17R (Jan 12 2021 15:53:43)

Hw-Version: 9.0.1  
Energy Pack: BP-LI0-1525  
Port: COM7

Cpu Core: 38 °C

Buttons: Reset Parameter..., Save...



## C Safety instructions



### **WARNING!**

Disregarding of following issues can result in electric shock, fire, serious injury or death.

1. Care must be taken to ensure proper and professional wiring.
2. The device pack must not be exposed to fire and temperatures outside the specification.
3. The device must not be immersed in water or exposed to splash water.
4. The device must not be operated in a humid environment or in an environment where dew and condensation are to be expected.
5. The device must not be opened, short-circuited, reversed, overheated or otherwise soldered/ welded.
6. Changes or attempts to repair the device are to be omitted.
7. Effects of foreign objects on the device must be avoided (e.g. metal parts).
8. Do not put obviously damaged devices into operation (e.g. dents, burn marks, rough contamination).
9. Keep ventilation openings clear.
10. Device must not be dropped.
11. All parts of the device and accessories must not be eaten or swallowed.
12. A current limited source is to be used. The required current values for the UPS are described in this manual.
13. The UPS is supplied with voltage from both the input source and the energy storage. The latter is still energized even after the input source has been disconnected.



### **ATTENTION!**

1. Improper use and opening of the device will void the warranty.
2. The device may only be used as intended.
3. The national accident prevention and safety regulations must be observed.
4. The assembly of the device and the electrical installation have to be state of the art.
5. The electrical, thermal and mechanical limit values have to be observed.
6. The UPS wiring specifications - as described in this manual - have to be followed.

## D Technical Data

### D1 General Technical Data

INPUT DATA – UPSI-2412DP2 / UPSI-2412DP3	
Unless otherwise stated, all specifications apply to 25 °C ambient temperature, 24 V DC input voltage and nominal output current ( $I_N$ ).	
Input voltage	24 VDC
Input voltage range	22.8 VDC...30 VDC
Electric strength max.	35 VDC
<b>Fixed connect threshold</b>	
Undervoltage	21.6 VDC
Voltage drop Input/Output	0.6 VDC max. (depending on load)
<b>Current consumption</b>	
$I_N$ ( $U_{N'} I_{OUT} = I_{N'} I_{CHARGE} = 0$ )	10.1 A
$I_{MAX}$ ( $U_{N'} I_{OUT} = I_{STAT.BOOST'} I_{CHARGE} = \max$ )	11 A
$I_{DYN}$ ( $U_{N'} I_{OUT} = I_{DYN.BOOST'} I_{CHARGE} = 0$ )	12 A
$I_{NO-LOAD}$ ( $U_{N'} I_{OUT} = 0, I_{CHARGE} = 0$ )	<100 mA
$I_{CHARGE}$ ( $U_{N'} I_{OUT} = 0, I_{CHARGE} = \max$ )	4.5 A
<b>Power consumption</b>	
$P_N$ ( $U_{N'} I_{OUT} = I_{N'} I_{CHARGE} = 0$ )	242 W
$P_{MAX}$ ( $U_{N'} I_{OUT} = I_{STAT.BOOST'} I_{CHARGE} = \max$ )	264 W
$P_{DYN}$ ( $U_{N'} I_{OUT} = I_{DYN.BOOST'} I_{CHARGE} = 0$ )	288 W
$P_{CHARGE}$ ( $U_{N'} I_{OUT} = 0, I_{CHARGE} = \max$ )	108 W
Internal input fuse	Yes (12 A)
Switch-on time	<5 s
Switch-on time battery start (BS) – <b>only with DP3</b>	<5 s

**OUTPUT DATA – UPSI-2412DP2 / UPSI-2412DP3 (NORMAL MODE)**

Unless otherwise stated, all specifications apply to 25°C ambient temperature, 24 V DC input voltage and nominal output current ( $I_N$ ).

Output voltage	24 VDC
Output voltage range	$U_{OUT} = U_{IN} - 0.6$ VDC max. (depending on load)
Capacitive load	10 000 $\mu$ F (at start / 0 A output load)
<b>Output current</b>	
$I_N$	10 A
$I_{STAT.BOOST}$	10.2 A
$I_{DYN.BOOST}$	10.3...12 A for max. 10 s
$I_{SFB}$	30 A (5 ms)
<b>Output power</b>	
$P_N (U_N, I_{OUT} = I_N, I_{CHARGE} = 0)$	234 W
$P_{STAT.BOOST} (U_N, I_{OUT} = I_{STAT.BOOST}, I_{CHARGE} = 0)$	239 W
$P_{DYN.BOOST} (U_N, I_{OUT} = I_{DYN.BOOST}, I_{CHARGE} = 0)$	241...280 W for max. 10 s
Short-circuit proof	Yes
No-load proof	Yes
Overcurrent shutdown	10.3...12 A for max. 10 s; 12.1...16.3 A for max. 100 ms >16.3 A for max. 5 ms

**OUTPUT DATA – UPSI-2412DP2 / UPSI-2412DP3 (BATTERY MODE)**

Unless otherwise stated, all specifications apply to 25 °C ambient temperature, 24 V DC input voltage and nominal output current ( $I_N$ ).

Output voltage	23.5 VDC
Output voltage range	n.a.
<b>Output current</b>	
$I_N$	10 A
$I_{STAT.BOOST}$	10.2 A
$I_{DYN.BOOST}$	10.3...12 A for max. 10 s
$I_{SFB}$	30 A (5 ms)
<b>Output power</b>	
$P_N (U_N, I_{OUT} = I_N, I_{CHARGE} = 0)$	235 W
$P_{STAT.BOOST} (U_N, I_{OUT} = I_{STAT.BOOST}, I_{CHARGE} = 0)$	240 W
$P_{DYN.BOOST} (U_N, I_{OUT} = I_{DYN.BOOST}, I_{CHARGE} = 0)$	242...282 W for max. 10 s
Short-circuit proof	Yes
No-load proof	Yes
Overcurrent shutdown	10.3...12 A for max. 10 s; 12.1...16.3 A for max. 100 ms >16.3 A for max. 5 ms
Load current for battery start (BS) – <b>only with DP3</b>	7 A max.
Switching time normal mode $\gg$ battery mode	<600 $\mu$ s

**CONNECTION DATA INPUT / OUTPUT**

Connection method	Screwable plug connector
Conductor cross-section solid	0.205 mm <sup>2</sup> ... 3.31 mm <sup>2</sup> (24 ... 12 AWG)
Conductor cross-section flexible	0.205 mm <sup>2</sup> ... 3.31 mm <sup>2</sup> (24 ... 12 AWG)
Conductor cross-section with ferrule	0.205 mm <sup>2</sup> ... 3.31 mm <sup>2</sup> (24 ... 12 AWG)
Stripping length	7 mm ... 8 mm
Tightening torque	0.5 Nm ... 0.6 Nm

**ENERGY STORAGE UPSI-2412DP2 (BP-SUC-30090)**

Charging method	CC / CV / CP
Nominal voltage U <sub>N</sub>	32V
End-of-charge voltage	32V
Charging current	4.5 A max.
Undervoltage protection	16V
Battery technology	EDLC
Nominal capacity	13.5 kJ (9.0 kJ useful) / 3.75 Wh (2.5 Wh useful)
Charging time (I <sub>charge_max</sub> )	11 min
Buffer time (I <sub>N</sub> )	39 sec

**ENERGY STORAGE UPSI-2412DP3 (BP-LFP-2725)**

Charging method	CC / CV / CP
Nominal voltage U <sub>N</sub>	25.6V
End-of-charge voltage	27.6V
Charging current	≤2 C (4.5 A max.)
Undervoltage protection	2.4V (cell level)
Battery technology	LiFePO4
Nominal capacity	2.5 Ah / 64Wh
Charging time (I <sub>charge_max</sub> )	49 min
Buffer time (I <sub>N</sub> )	14 min 30 sec

<b>CONNECTION DATA – RELAY</b>	
Connection labeling	RL
Switch contact (potential free)	Relay
Status (configurable)	Power Fail Alarm
Switching voltage	24 VDC / 125 VAC
Current carrying capacity	1 A (DC) / 0.5 A (AC)
State - signal assignment	NO (Normally Open) / NC (Normally Closed) – configurable via Software (see UPS Gen <sup>2</sup> software manual)
Switching time	1500 ms max.

<b>DATA INTERFACE – USB</b>	
Interface designation	USB
Numbers of interfaces	1
Connection method	USB type B (female)
Locking	No
Transmission physics	USB 2.0
Topology	Point-to-point
Protocol	VCOM, HID
Transmission length	≤3 m
Access time	<1 s
Chipset	NXP
Electrical isolation	No

<b>DATA INTERFACE – RS232</b>	
Interface designation	RS232
Numbers of interfaces	1
Connection method	DSUB 9-Pin (female)
Locking	No
Transmission physics	RS232 light (TX / RX)
Topology	Point-to-point
Symbol rate (baud rate)	38400
Type of cable	1:1
Transmission length	≤10 m
Access time	<1 s
Voltage level	-6 VDC ... +6 VDC
Electrical isolation	No

<b>GENERAL DATA</b>	
Flammability class according to UL 94 (housing / terminal blocks)	V0
Weight	DP2: 1.72 kg, DP3: 1.53 kg
UPS connection in parallel	No
UPS connection in series	No

<b>HOUSING</b>	
Degree of protection	IP 20
Protection class	III (without PE)
Mounting type	DIN-Rail mounting (EN 60715)
Housing version	Aluminium
Dimension W / H / D	111 mm / 157 mm / 131 mm (without front connectors and DIN-Rail mounting bracket)

<b>ENVIRONMENTAL CONDITIONS</b>	
Ambient temperature (operation)	DP2: -20... +70 °C / DP3: -20... +55 °C
Ambient temperature (start up without load)	DP2: -30 °C / DP3: -20 °C
Ambient temperature (storage / transport)	DP2: -30...+70 °C / DP3: -30...+55 °C
Max. permitted humidity	≤95 % (bei +25 °C, no dew)
Operating altitude	≤4000 m
Climate class	3k3 (EN 60721)
Degree of pollution	2
<b>Overvoltage category</b>	
EN 61010-1	I
EN 61010-2-201	I
Indoor / Outdoor use	Yes / Yes (in housing)

<b>STANDARDS</b>	
Safety extra-low voltage	IEC 61010-1 (SELV) IEC 61010-2-201

<b>APPROVALS</b>	
UL	n.a. (possible upon consultation)
CSA	
CB Scheme	

<b>INTERFERENCE IMMUNITY ACCORDING TO EN 61000 (INDUSTRY)</b>	
<b>Basic standard CE</b>	<b>Fulfilled requirements according to EN 61000 (CE) (Interference immunity of industrial environment)</b>
<b>Electrostatic discharge</b> <b>EN 61000-4-2</b> Contact discharge Air discharge Comment	4 kV 8 kV Criterion A
<b>Electromagnetic HF field</b> <b>EN 61000-4-3</b> Frequency range Test field strength Frequency range Test field strength Comment	80 MHz ... 1 GHz 10 V/m 1.4 GHz ... 2 GHz 3 V/m Criterion A
<b>Fast transients (Burst)</b> <b>EN 61000-4-4</b> Test voltage Comment	2 kV Criterion A
<b>Surge voltage load (Surge)</b> <b>EN 61000-4-5</b> Test voltage L–N Test voltage L–PE, N–PE Comment	±1 kV ±2 kV Criterion A
<b>Induced radio-frequency fields</b> <b>EN 61000-4-6</b> Frequency range Test level Comment	0.15–80 MHz 10V; 150Ω source impedance; AM80%/1 kHz (sine) Criterion A
<b>Power frequency magnetic field immunity</b> <b>EN 61000-4-8</b> Test level Comment	30 A/m Criterion A



<b>EMISSION ACCORDING TO EN 61000-6-4 (INDUSTRY)</b>	
<b>Basic standard CE</b>	<b>Fulfilled requirements according to EN 61000-6-4 (CE) (Industrial environment)</b>
<b>Conducted emission from the power port</b> EN 61000-6-4 Frequency range Comment	150 kHz–30 MHz Conform
<b>Electric field radiated emission</b> EN 61000-6-4 Frequency range Comment	30 MHz–1 GHz Conform

<b>LEGEND</b>	
Criterion A	Normal operating behaviour within the defined limits.
Criterion B	Temporary impairment of the operating behaviour, that is corrected by the device itself.

## D2 Drawing

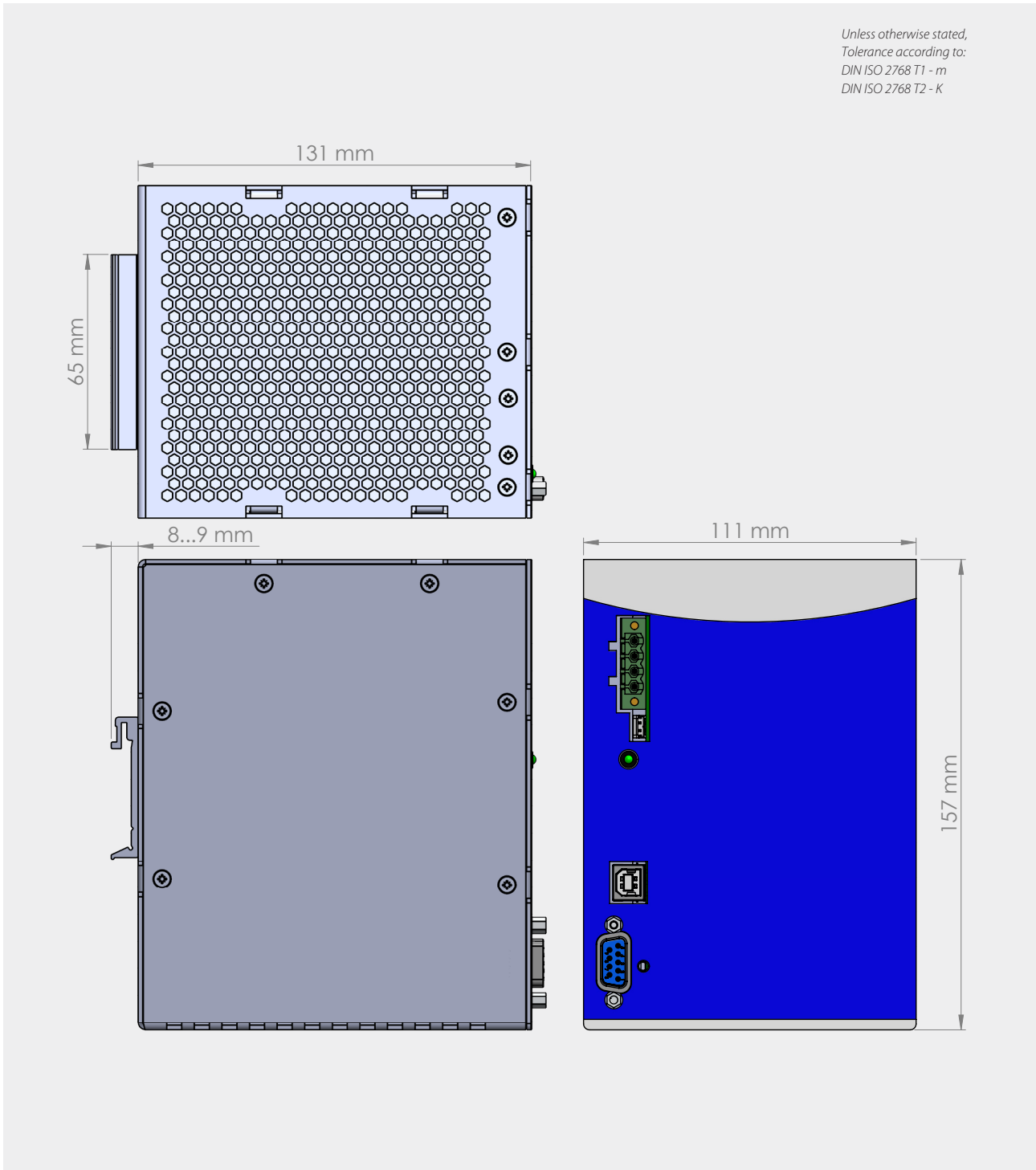

### E Name / Address / Support E-Mail / Phone number of the manufacturer

Bicker Elektronik GmbH · Ludwig-Auer-Straße 23 · 86609 Donauwörth · Germany

E-Mail: support@bicker.de · Tel.: +49 (0) 906 70595-0

## F General Data

### F1 Assembly and installation advice



**Installation and operation of this device is only allowed to be executed by a qualified electrician!** The application has to be separated from any power during the mounting process. Wires have to be connected safely and must not have contact with sharp edges. Pay attention to correct polarity! Before commissioning, check all the connections for correctness!

### F2 Convection and installation position

For these DIN rail versions, vertical mounting on a horizontal rail (DIN rails according to EN 60715) is recommended in order to achieve the best possible convection of the UPS. Another mounting position is possible, but operation up to the respective highest ambient temperature can not be guaranteed.

Make sure that no ventilation holes are covered by other, neighboring components and devices.

The following distances to neighboring devices are recommended:

Left / right: 20 mm

Top / bottom: 50 mm

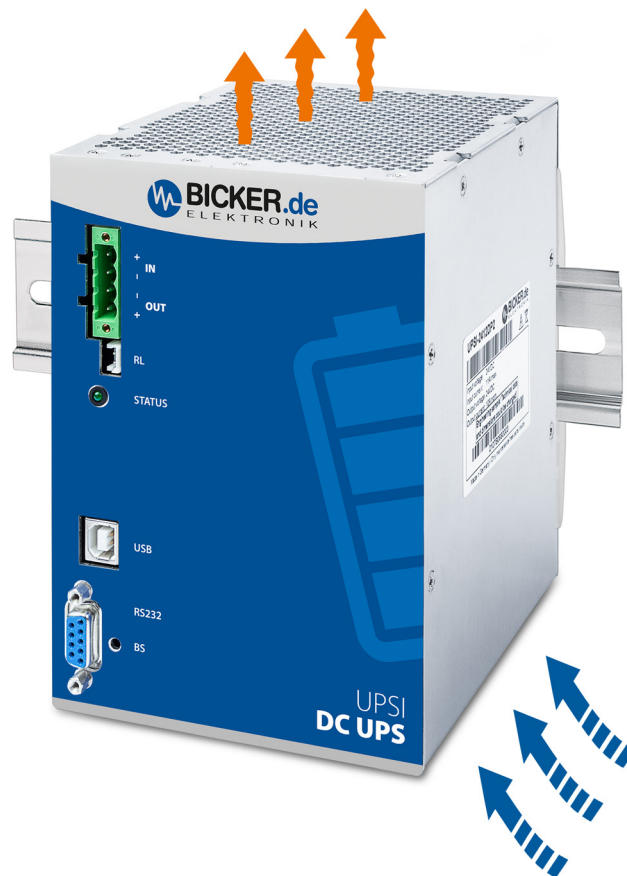

The devices comply with the IP protection class 20.

## DIN-Rail mounting and DIN-Rail profile according to EN 60715

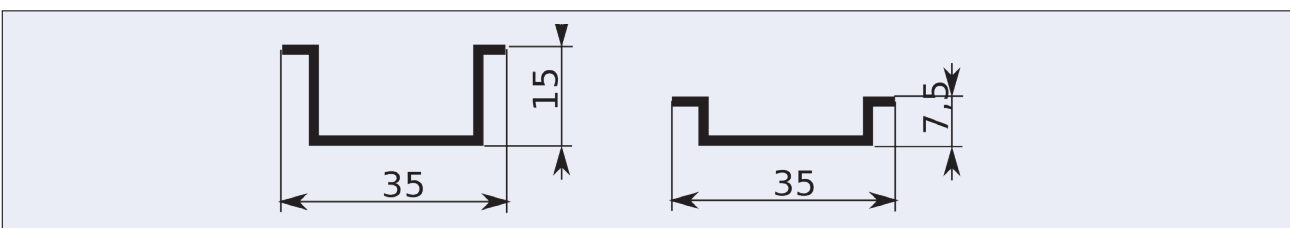
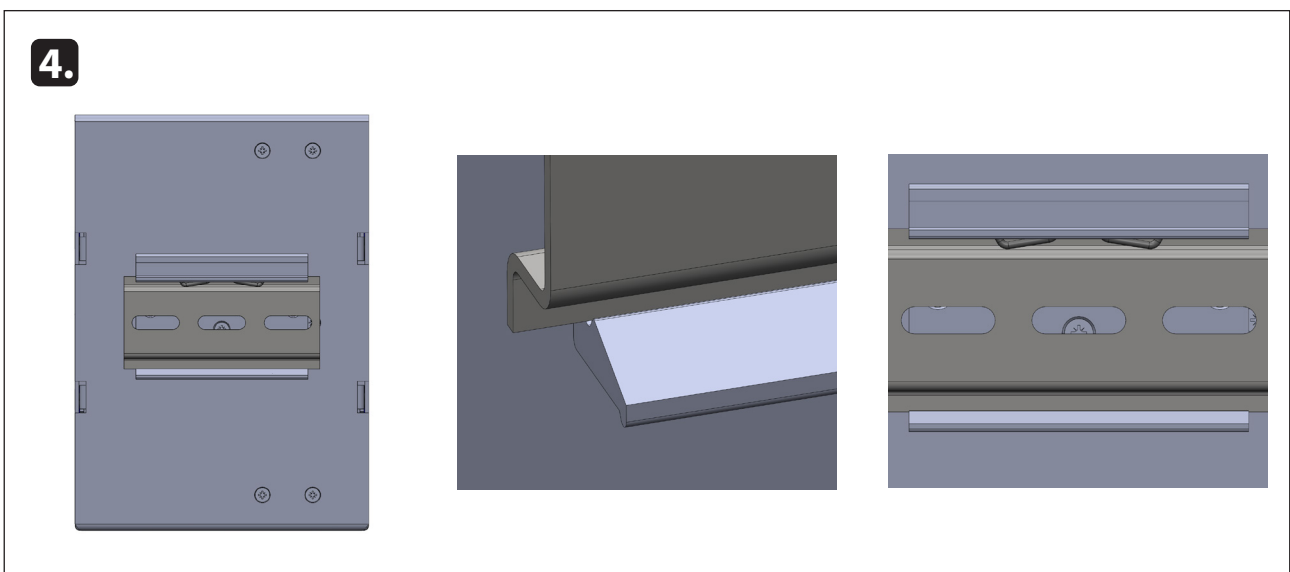
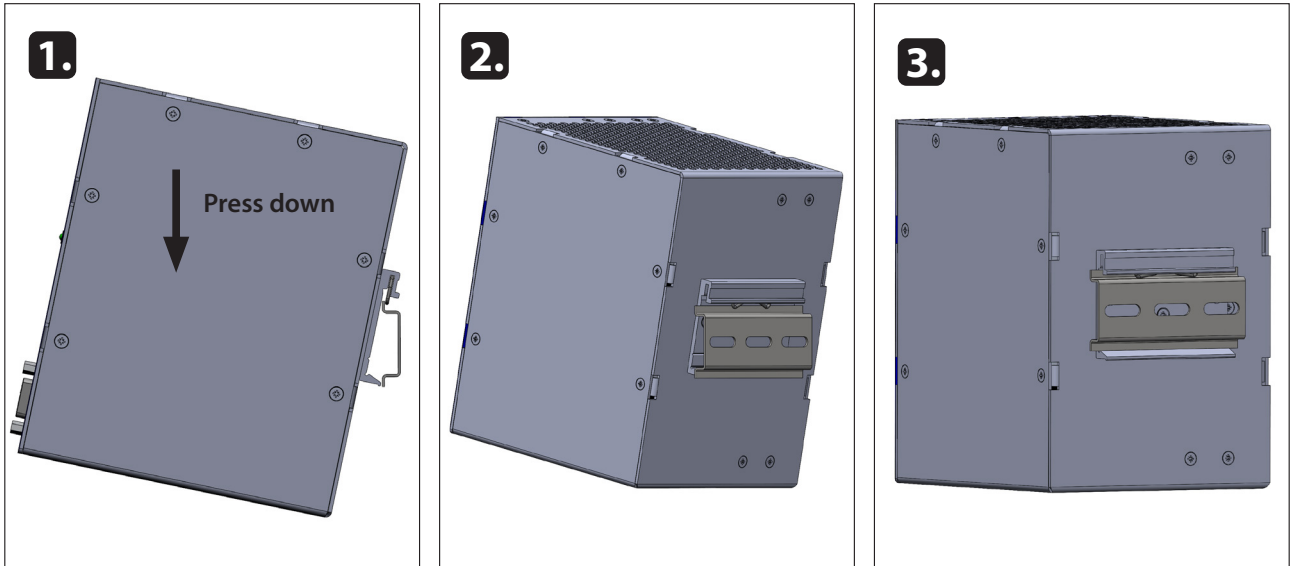

### F3 Description of connectors

#### INPUT & OUTPUT (IN & OUT)

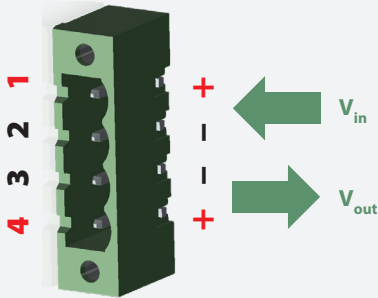

PIN	FUNCTION
1	Vin +
2	Vin -
3	Vout -
4	Vout +

#### RELAY CONNECTION (RL)

The function of the relay connection is configurable via software. When closing the relay the resistor value between both contacts is approx. 0 Ω, otherwise they are „open load“.

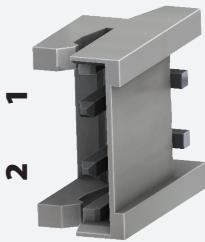

PIN	FUNCTION
1	Relay contact 1
2	Relay contact 2

#### RS-232

To enable PIN 8, PIN 1 has to be permanently switched to PIN 5 (GND).



PIN	FUNCTION
1	PIN 8 ENABLE
2	TXD
3	RXD
4	DSR
5	GND
6	DTR
7	NC
8	+5V (4.9V at 20mA / 4.6 V at 50mA)
9	NC

## F4 Dimensioning the upstream power supply

Ensure that the upstream power supply is correctly dimensioned to guarantee the charging process of the batteries and the correct functioning of the application. The input has to be supplied from a SELV or PELV power supply. In order to operate the UPS devices with complete functionality, the upstream power supply has to provide at least 24V/20A and use **no** constant current function.

If less load than the maximum load is required at the output, the voltage supply can be dimensioned according to the table below (column 3).

UPSI-2412DP2 / UPSI-2412DP3		
$I_{LOAD}$ [A]	$I_{CHARGE}$ [A]	$I_{IN-MIN}$ [A]
0	4.5	5
1	4	5.5
2	3.7	6
3	3.4	7
4	3	7.5
5	2.6	8
6	2.3	9
7	1.8	9.5
8	1.6	10
9	1.2	11
10	1.0	12

## F5 Connecting diagram

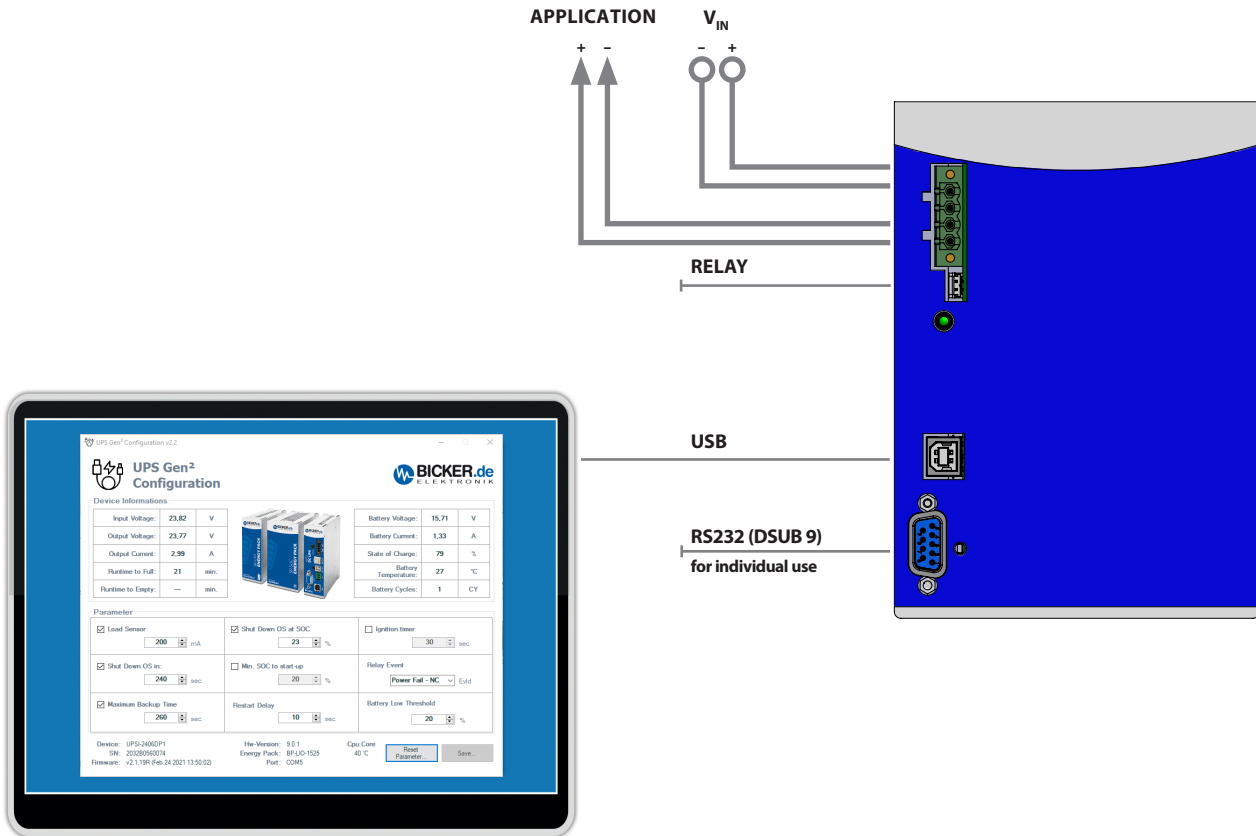

### CONNECTING ORDER

1. APPLICATION ( $V_{OUT}$ )
2. DC SOURCE ( $V_{IN}$ )
3. RELAY / USB / RS232

**Dismantling order reverse to connection!**



### $V_{IN}/V_{OUT}$ - ATTENTION!

1. Note polarity!
2. AWG16 wire should be used (1.5 mm<sup>2</sup>)

## F6 Initial operation

The correct installation of the UPS has to be ensured. After that, the start can take place in two ways:

### 1. By connecting the supply voltage (standard):

If a voltage more than 22.8 V is connected to the input terminals, the energy storage is queried and transmits its data. The UPS sets the appropriate end-of-charge voltage and releases the pack via system present. After that, the charging of the energy storage starts.

OR

### 2. Starting the battery from the energy storage into battery mode (alternative – only with UPSI-2412DP3):

By pressing the BS button for more than 2 seconds (max. 5 s). See also chapter F12 „Battery start“.

The applied voltage at the input of the UPS is passed through to the output, reduced by a current-dependent voltage drop ( $V_{OUT} = V_{IN} - 0.6 \text{ V}$  at maximum current). The device charges the energy storage and monitors the upstream voltage thresholds at the input (UPS function).

It must be ensured that the source supplies enough current to guarantee the charging process (see chapter F4 „Dimensioning the upstream power supply“).



Even after disconnecting the upstream source and also no voltage is measurable at the output, the UPS can be still powered by the energy storage.



## F7 Overview connector / Counterpart with description / Scope of delivery

CONNECTOR	PART NO.	COUNTERPART NO.
$V_{IN} / V_{OUT}$	Würth Elektronik 691317510004	Würth Elektronik 691340500004
RL	Würth Elektronik 68800211722	Würth Elektronik 688002113322
USB	Würth Elektronik 61400416121	USB type B connector
RS232	D-Sub9 Female	D-Sub 9 Male

SCOPE OF DELIVERY	
QUANTITY	DESCRIPTION
1x device	UPSI-2412DP2 or UPSI-2412DP3 - DC UPS
1x	$V_{IN} / V_{OUT}$ connector counterpart
1x	Relay cable, 50 cm, AWG 22

## F8 Charging time

Charging times depend on energy storage, input voltage and the load current.

## F9 Reverse polarity / Overcurrent / Short circuit

Reverse polarity:

The device has passive reverse polarity protection at the input. In the event of reverse polarity, the input fuse trips irreversibly and the device goes into a safe state.

Overcurrent:

If the load current at the output is too high, the device switches it off. For maximally allowed current values and peak current values refer to chapter D „Technical Data“. The status LED indicates the error status by means of a very rapid flashing sequence. A restart attempt occurs every 10 seconds in normal mode. During battery mode there is no restart attempt.

Short circuit:

In the event of a short-circuit at the output of the UPS, the output is immediately disconnected (<5 ms). The status LED indicates the error status by means of a very rapid flashing sequence. A restart attempt occurs every second in normal mode (non-latch). During battery mode there is no restart attempt. The impact of a short-circuit to the device depends on length and diameter (impedance) of the output wiring. In case of a short-circuit directly at the plugs a damage of the device can occur.

## **F10 Backup time in battery mode**

The nominal backup times can be found within the technical data of this user manual or the user manuals/datasheets of the used energy storages. At extreme low or high temperatures a reduction of the nominal backup times can occur.

## **F11 Behaviour in case of exceeding maximum backup time**

When the given buffering times are exceeded, the output is separated on the basis of the discharge voltage of the corresponding energy storage (total discharge protection).

With supercapacitors in particular, an additional switch-off threshold can take effect if the discharge current of the energy storage device is too high (>15 A). This can occur at very high load currents at the output of the UPS. The lower the voltage of the energy storage device decreases, the higher the discharge current so that a constant power is ensured at the output of the UPS.

If the allowable output current during battery mode exceeds more than 70%, the converter switches off first, without separating the output immediately. In this case, the voltage at the output of the UPS can drop significantly below 23.5 V. This condition should be avoided by shutting down the system in time.

## **F12 Battery start (only with UPSI-2412DP3)**

This function enables the application or the device to be started from the battery up to a maximum load current of 7 A without the power supply being available or connected. To do this, the BS button has to be pressed through the hole in the front of the housing with a fine object (thin screwdriver or similar) for more than 2 seconds (max. 5 s). This is only useable with UPSI-2412DP3.

## F13 Status LED

Valid from firmware version 2.2.6

MAIN STATES		
	Always on	<b>Status: mains voltage</b> >> Mains voltage is present.
	1 Hz flash (1 s on, 1 s off)	<b>Status: Battery mode</b> >> Mains voltage is not present.
INTERNAL STATES		
	1 x flash (LED is off briefly), pause 2 s	<b>Status: Battery start*</b> >> Manual start from the battery by pressing the BS button.
	2 x flash (LED is off briefly), pause 2 s	<b>Status: Capacity not reached</b> >> Capacity is required. Output is only activated when the battery is charged to set SOC.
	3 x flash (LED is off briefly), pause 2 s	<b>Status: Shutdown</b> >> UPS has received a shutdown signal and is waiting until the set load sensor value has fallen below.
	4 x flash (LED is off briefly), pause 2 s	<b>Status: Reboot</b> >> Output is deactivated and time until reboot runs (Reboot phase).
BATTERY FAILURES		
	1 x flash (LED is off a long time), pause 2 s	<b>Status: No battery detected</b>
	2 x flash (LED is off a long time), pause 2 s	<b>Status: Battery overvoltage</b> >> Charge voltage at battery is too high, battery is deactivated.
	3 x flash (LED is off a long time), pause 2 s	<b>Status: Battery overcurrent</b> >> Charge current at battery is too high, battery is deactivated.
	4 x flash (LED is off a long time), pause 2 s	<b>Status: Battery temperature failure</b> >> Battery temperature sensor was not detected or battery temperature is too high or low.
UPS FAILURES		
	Quick flashing without pause	<b>Status: UPS failure</b> >> Output current too low, UPS is deactivated. >> Overcurrent at output (charge current too high), output is deactivated >> Short circuit at output, output is deactivated >> Internal failure, UPS is deactivated.

\* Only usable with UPSI-2412DP3

## F14 Shutdown diagram

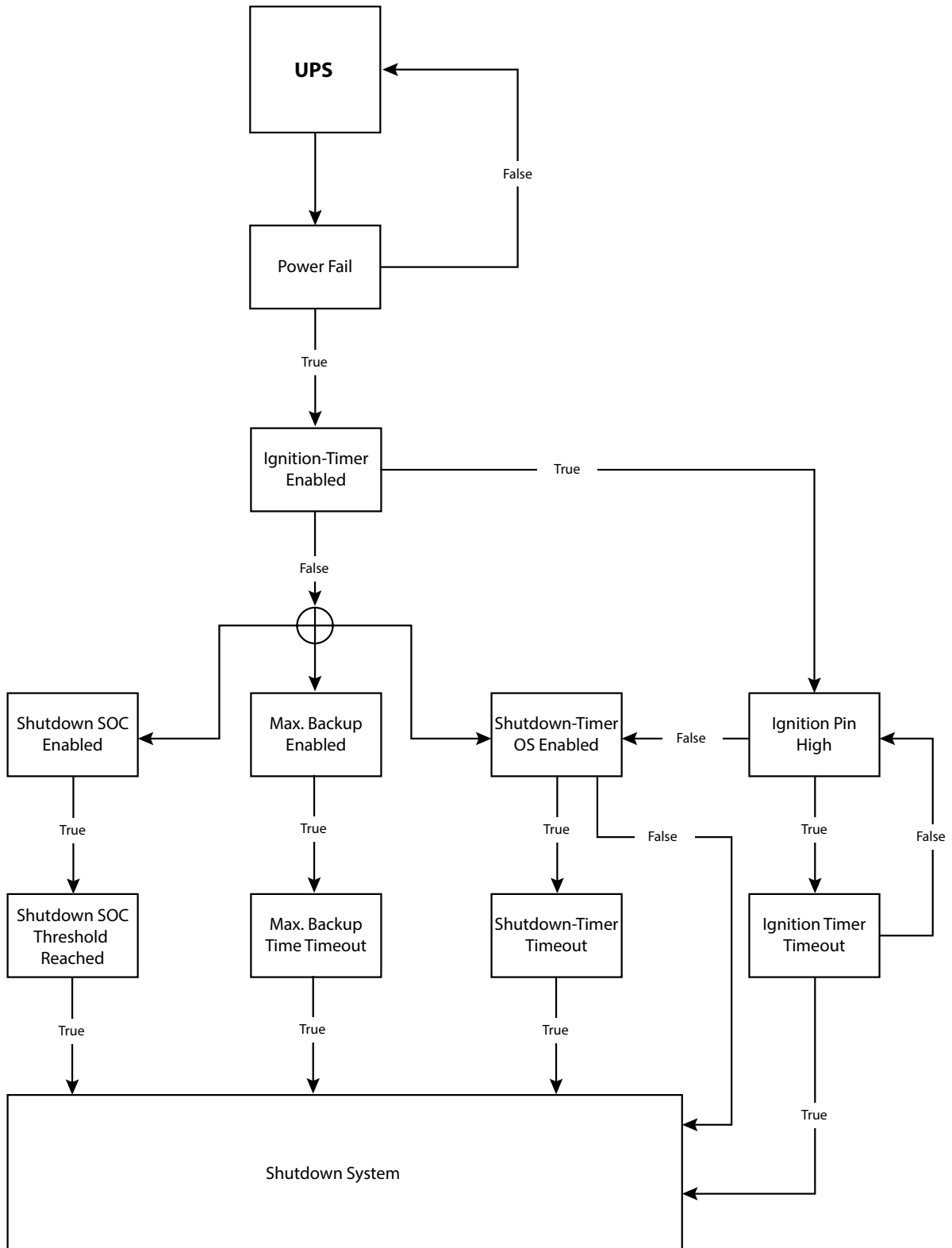

## F15 Recommendations for a long UPS service life

Over time, the capacity of the Supercaps decreases and the ESR (equivalent series resistance) increases. However, EOL is often defined as a reduction in capacity to 70% and a doubling of the ESR. An important aspect for the aging of the Supercaps is the end-of-charge voltage and the operating temperature.

LiFePO<sub>4</sub> batteries also age over time depending on cycles, operating temperature and the level of the end-of-charge voltage. The end-of-charge voltages are optimized so that they are at an optimum between service life and performance.

To extend the lifetime of the system, the device should not be placed near sources of heat and should be placed within good air-circulation. When using the UPSI-2412DP3 (LiFePO<sub>4</sub> battery), a larger capacity than actually required should always be used. The less deep the packs are discharged, the longer the service life lasts.

## F16 Maintenance

The UPS contains no serviceable parts. In case of a malfunction the upstream power source has to be disconnected and cables have to be removed. Use a dry cloth for cleaning!

## F17 Disposal

Electric and electronic devices must not be disposed with domestic waste!  
Please consider to each country's own regulation about recycling and disposal of used batteries at the end of their lifetime or resending to any recycling organization.



## F18 Disclaimer

We, the Bicker Elektronik GmbH, have checked the contents of this document for compliance with the hardware and software described. Nevertheless, deviations can not be ruled out, so we assume no liability for the complete agreement. The information in this publication is checked regularly, necessary corrections are included in the updated versions.

Suggestions for improvement as well as tips and criticism are always welcome.

## **F19 Preventive measures and rules when operating the UPS system**

The voltage drop of the supply line has to be kept in mind! The maximum charge current can cause huge voltage drops if too long supply lines are used. If the voltage drop is too high a shortfall of the threshold values is possible and a not intended Power Fail could be caused. With maximum load the voltage at the input of the device must not undercut 22.8V.

Even after the upstream supply has been disconnected, the device continues to run for some time after the shortfall of the load sensor (setting of a threshold value for current: currents below this value will be classified as „system off“ (no load)).

A short direct at the output of the device can cause damage or destruction of the UPS. In the event of a fault, electrolytes can escape in liquid and gaseous form.

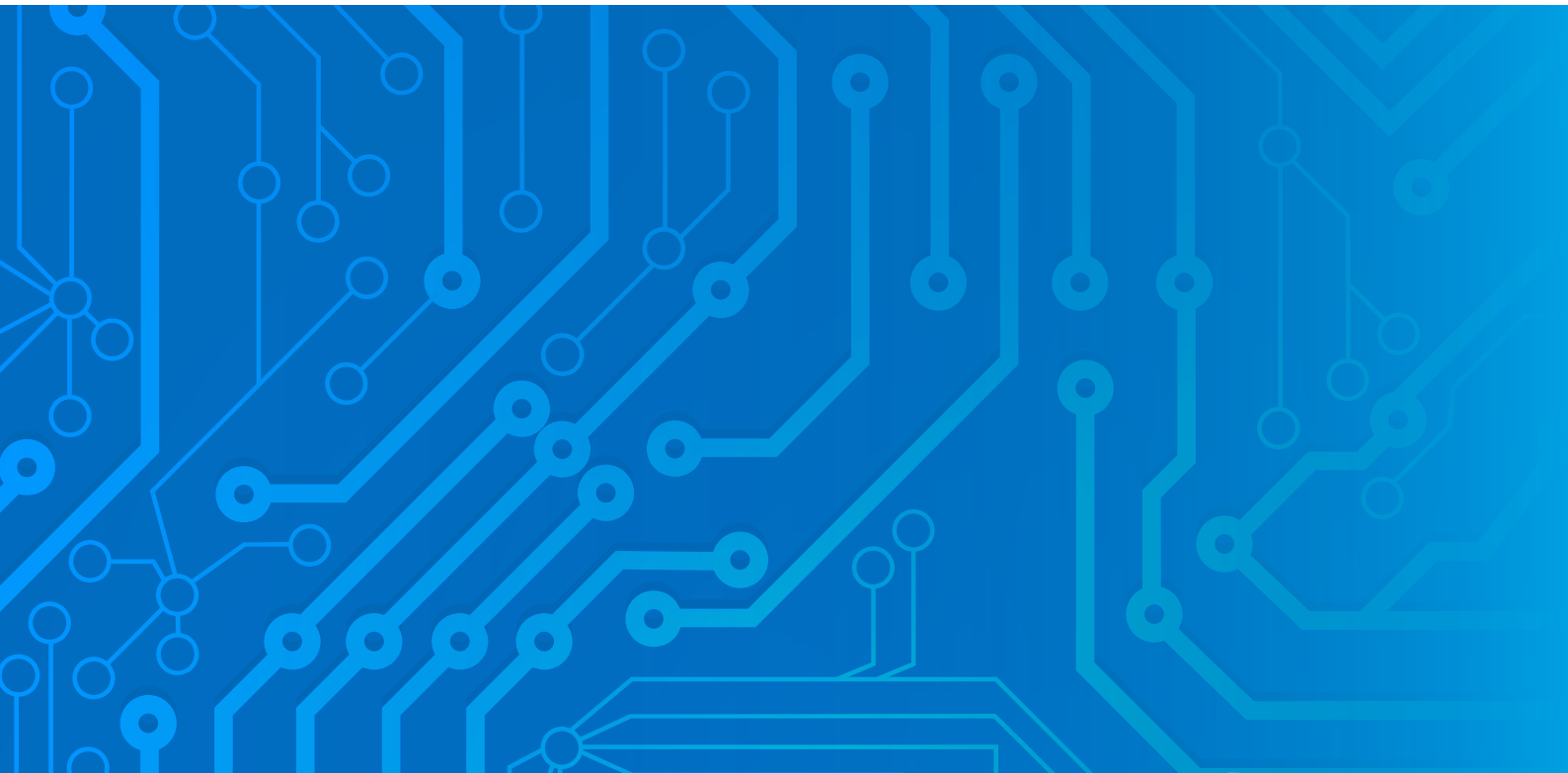

Note: Subject to errors and technical modifications!  
Windows® is a registered trademark of the Microsoft Corp.  
Status as at: 08.03.2022 – Revision 1-3



---

Bicker Elektronik GmbH  
Ludwig-Auer-Straße 23  
86609 Donauwörth · Germany  
Tel. +49 (0) 906 70595-0  
Fax +49 (0) 906 70595-55  
E-Mail [info@bicker.de](mailto:info@bicker.de)  
**[www.bicker.de](http://www.bicker.de)**