





English

User Manual | **UPSI-2406DPx**

UPS SYSTEM
DIN-RAIL



Legend of used symbols

Symbol	Description
	Attention! Important hazard warning.
	Do not dispose of in the domestic waste.
	Warning of electrical voltage.

Revision Directory

Date	Change
31.03.2020 Revision 0-1	Initial version
10.06.2020 Revision 1	Release version
03.07.2020 Revision 1-1	Chapter B2 extended, Chapter B3 Environmental condition extended, Chapter C1 Input data Internal input fuse changed Chapter C1 Environmental conditions extended.
16.07.2020 Revision 1-2	PELV indication removed
12.08.2020 Revision 1-3	Chapter B3 Intended use more detailed specified Chapter C1 Environmental conditions more detailed specified (Indoor/Outdoor) Page 2, Warning „Read User Manual“ at explanation „Legend of used symbols“ supplemented
25.11.2020 Revision 1-4	Model UPSI-2406DP3 integrated
21.10.2021 Revision 1-5	Basic revision of individual chapters, updated backup time diagrams, B rebuilt, E14 software removed, F9 rebuilt, F12 status LED rebuilt, new image in F5, E5 images removed, F13 Shutdown diagram added
02.05.2022 Revision 2-0	Brief specifications divided (DP1, DP2, DP3), DP3 newly integrated, technical data updated, pictures updated, F12 Dynamic Powerboost added
27.04.2023 Revision 2-1	Chapter B3 UPScom Software integrated

A Brief specification

UPSI-2406DP1

24 VDC / 4 A

- ✓ 24 V DC UPS (DIN-Rail version)
- ✓ Integrated Li-Ion battery
- ✓ Up to 500 cycles
- ✓ Capacity: 37 Wh
- ✓ Intelligent input current detection
- ✓ Regulated output voltage in battery mode
- ✓ Minimum load detection
- ✓ Power-fail timer function
- ✓ Relay dry contact on power fail
- ✓ Reboot function
- ✓ Fuel gauge
- ✓ Shutdown via external signal



Technical Data	
Input voltage	24 VDC (22.5 ... 30 V)
Input current	4.8 A max.
Output voltage	Normal mode: $V_{IN} - 0.5$ VDC max. (depending on load) Battery mode: 23.5 VDC
Output current	4 A nominal
Capacitive load	3000 μ F (in normal mode, at start, 0 A load)
Charging method	CC/CV/CP
Protection	Input: Reverse polarity protection Output: Overcurrent protection, Short circuit protection
Interface	USB, RS232, HID UPS
Battery technology	Li-Ion 2.5 Ah / 37 Wh
Ambient temperature	Operating Storage/Transport 0...+50°C -20...+50°C
Operating altitude	\leq 4000 m
Max. permitted humidity	\leq 95 % (at +25 °C, no dew)
Dimensions W/ H / D	63 x 120 x 100 mm (without front connectors and DIN-Rail mounting bracket)
Weight	0.6 kg

Backup time* UPSI-2406DP1 – Battery type: Lithium-Ion

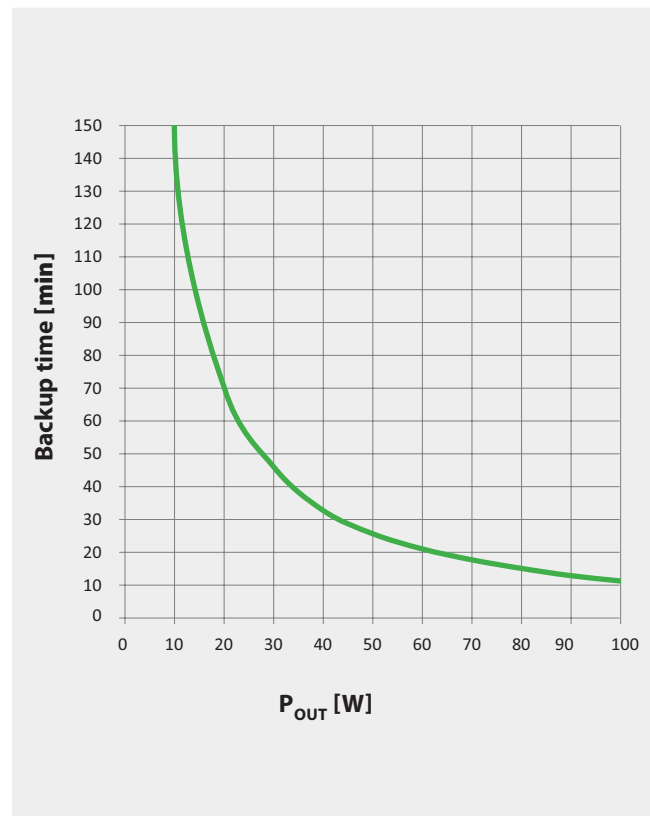
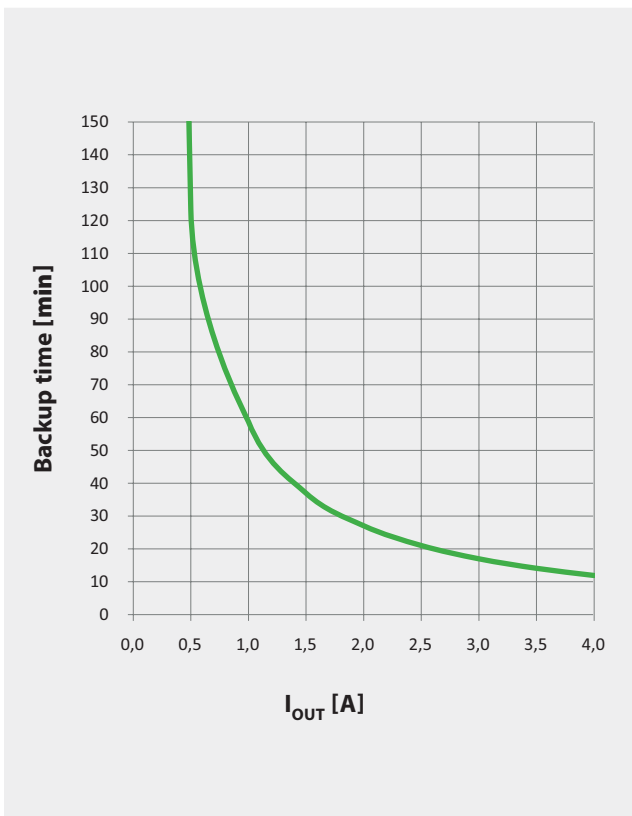
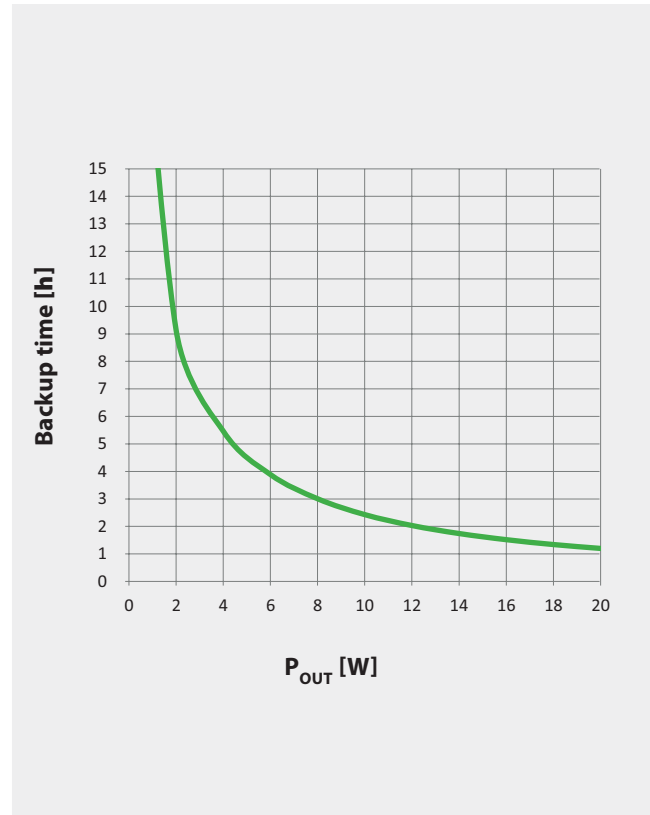
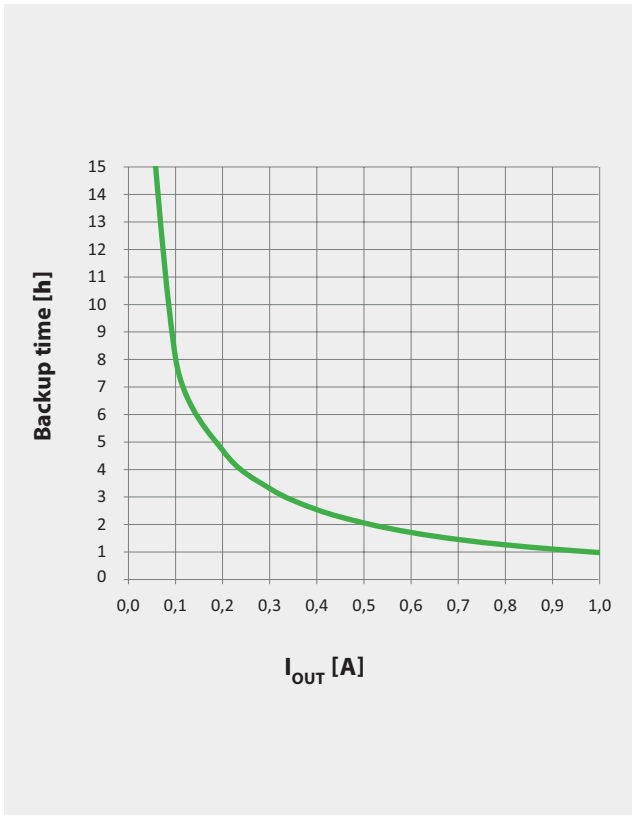

*Backup time depends on battery capacitance, load and temperature. At very high or low temperatures a reduction of backup time occurs. Unless otherwise specified, the values apply to measurements at +25 °C

A Brief specification

UPSI-2406DP2

24 VDC / 4 A

- ✓ 24 V DC UPS (DIN-Rail version)
- ✓ Integrated Supercaps
- ✓ Up to 500 000 cycles
- ✓ Capacity: 5.73 kJ
- ✓ Intelligent input current detection
- ✓ Regulated output voltage in battery mode
- ✓ Minimum load detection
- ✓ Power-fail timer function
- ✓ Relay dry contact on power fail
- ✓ Reboot function
- ✓ Fuel gauge
- ✓ Shutdown via external signal



Technical Data	
Input voltage	24 VDC (22.5 ... 30 V)
Input current	4.8 A max.
Output voltage	Normal mode: $V_{IN} - 0.5$ VDC max. (depending on load) Battery mode: 23.5 VDC
Output current	4 A nominal
Capacitive load	3000 μ F (in normal mode, at start, 0 A load)
Charging method	CC/CV/CP
Protection	Input: Reverse polarity protection Output: Overcurrent protection, Short circuit protection
Interface	USB, RS232, HID UPS
Battery technology	EDLC 5.73 kJ (3.88 kJ useful) / 1.59 Wh (1.08 Wh useful)
Ambient temperature	Operating Storage/Transport -20...+65 °C -30...+65 °C
Operating altitude	≤ 4000 m
Max. permitted humidity	≤ 95 % (at +25 °C, no dew)
Dimensions W/ H / D	63 x 120 x 100 mm (without front connectors and DIN-Rail mounting bracket)
Weight	0.6 kg

Backup time* UPSI-2406DP2 – Battery type: EDLC (Supercaps)

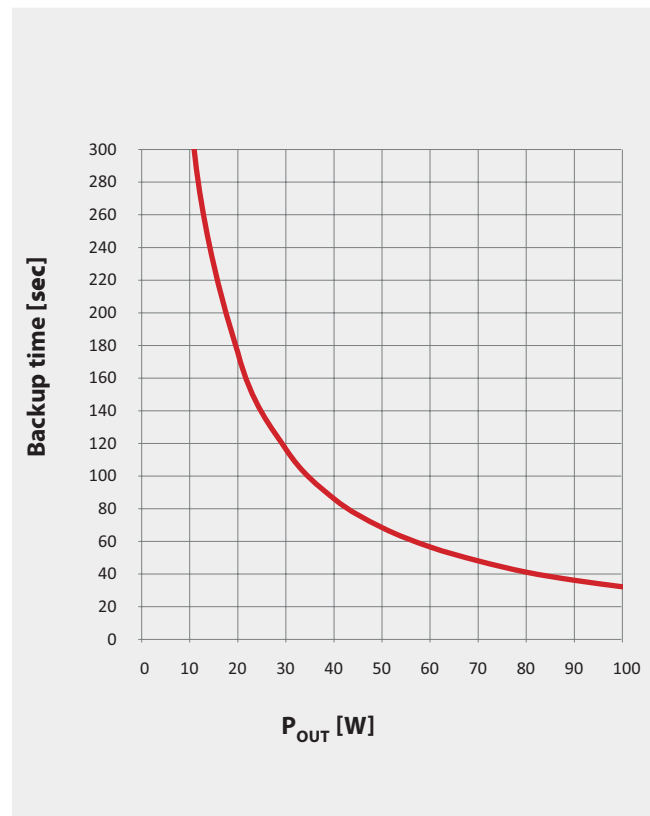
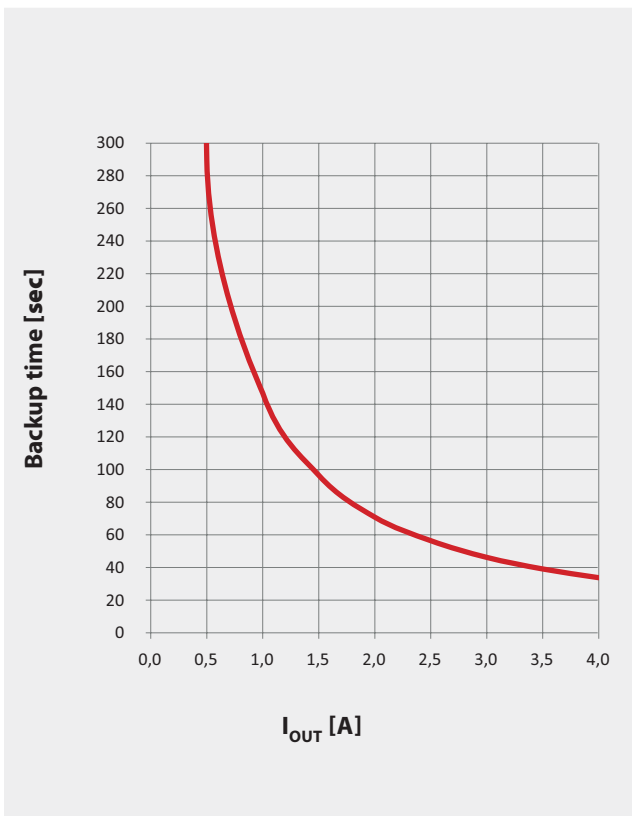
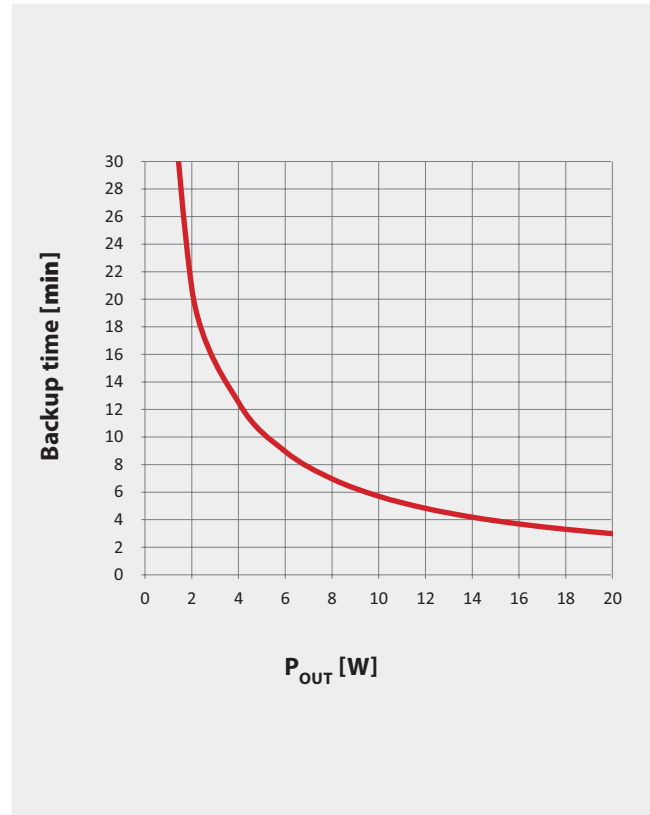
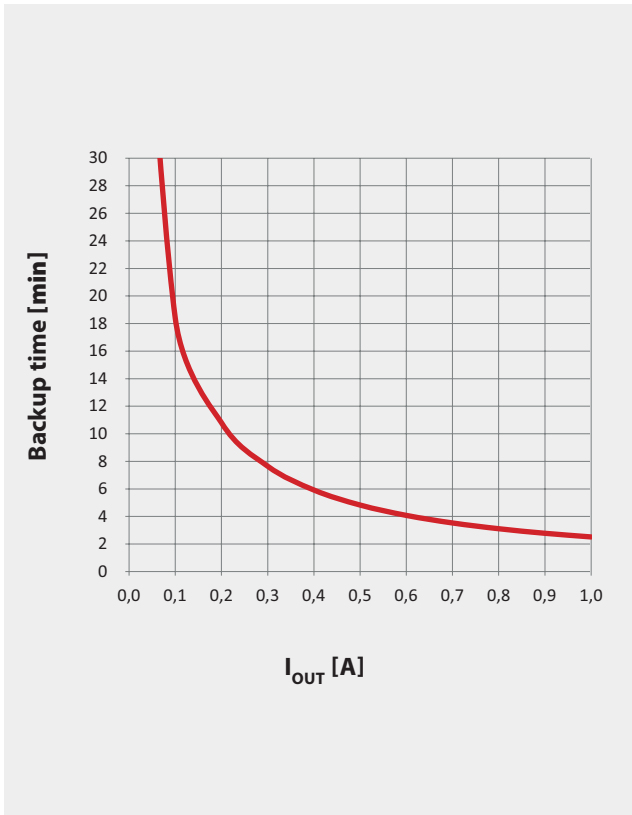

*Backup time depends on battery capacitance, load and temperature. At very high or low temperatures a reduction of backup time occurs. Unless otherwise specified, the values apply to measurements at +25 °C

A Brief specification

UPSI-2406DP3

24 VDC / 6 A

- ✓ 24 V DC UPS (DIN-Rail version)
- ✓ Integrated LiFePO4 battery
- ✓ Up to 6 000 cycles
- ✓ Capacity: 33 Wh
- ✓ Intelligent input current detection
- ✓ Regulated output voltage in battery mode
- ✓ Minimum load detection
- ✓ Power-fail timer function
- ✓ Relay dry contact on power fail
- ✓ Reboot function
- ✓ Fuel gauge
- ✓ Shutdown via external signal



Technical Data	
Input voltage	24 VDC (22.5 ... 30 V)
Input current	6.2 A max.
Output voltage	Normal mode: $V_{IN} - 0.5$ VDC max. (depending on load) Battery mode: 23.5 VDC
Output current	6 A nominal
Capacitive load	3000 μ F (in normal mode, at start, 0 A load)
Charging method	CC/CV/CP
Protection	Input: Reverse polarity protection Output: Overcurrent protection, Short circuit protection
Interface	USB, RS232, HID UPS
Battery technology	LiFePO4 2.5 Ah / 33 Wh
Ambient temperature	Operating Storage/Transport -20...+50°C -30...+55°C, recommended state of charge 80%
Temperature derating	See derating curve on next after next
Operating altitude	≤ 4000 m
Max. permitted humidity	≤ 95 % (at +25°C, no dew)
Dimensions W/ H / D	63 x 120 x 100 mm (without front connectors and DIN-Rail mounting bracket)
Weight	0.8 kg

Backup time* UPSI-2406DP3 – Battery type: LiFePO4

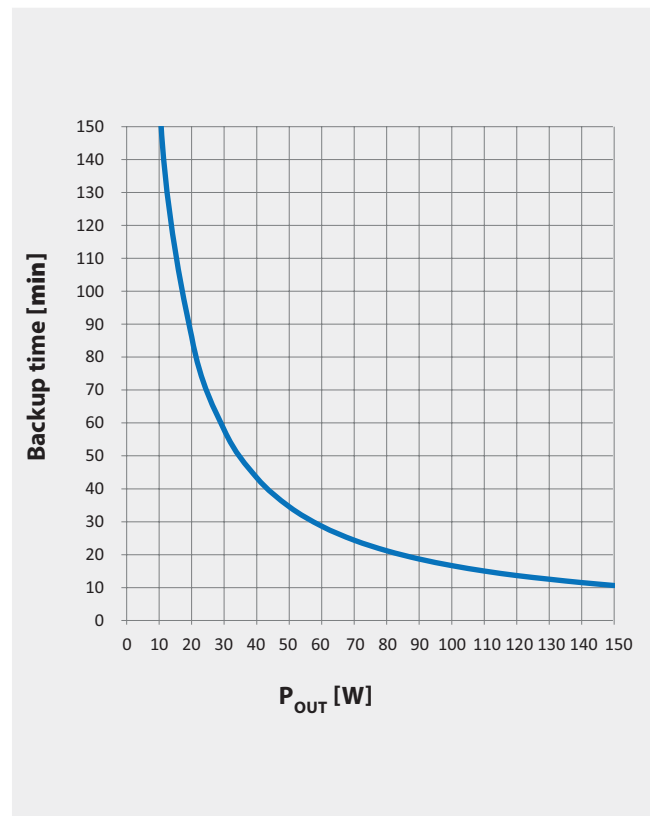
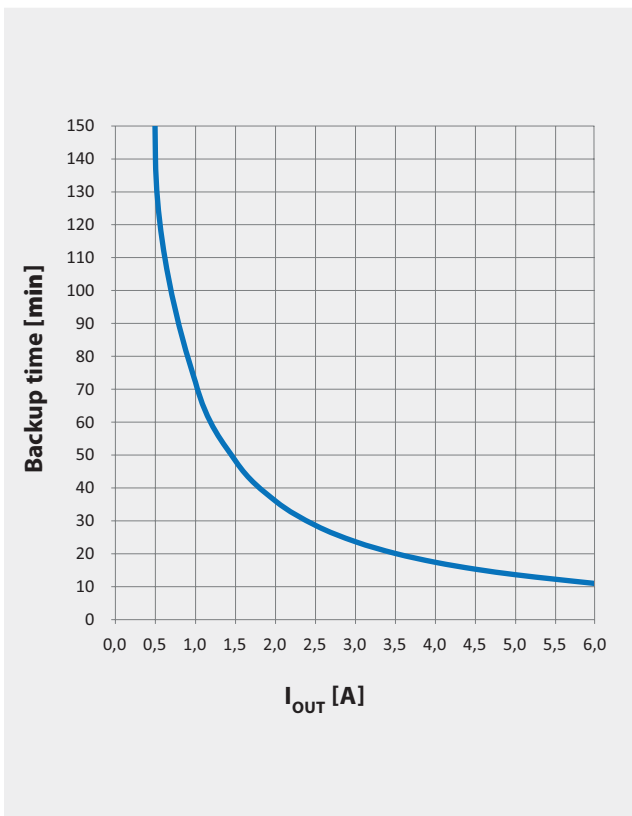
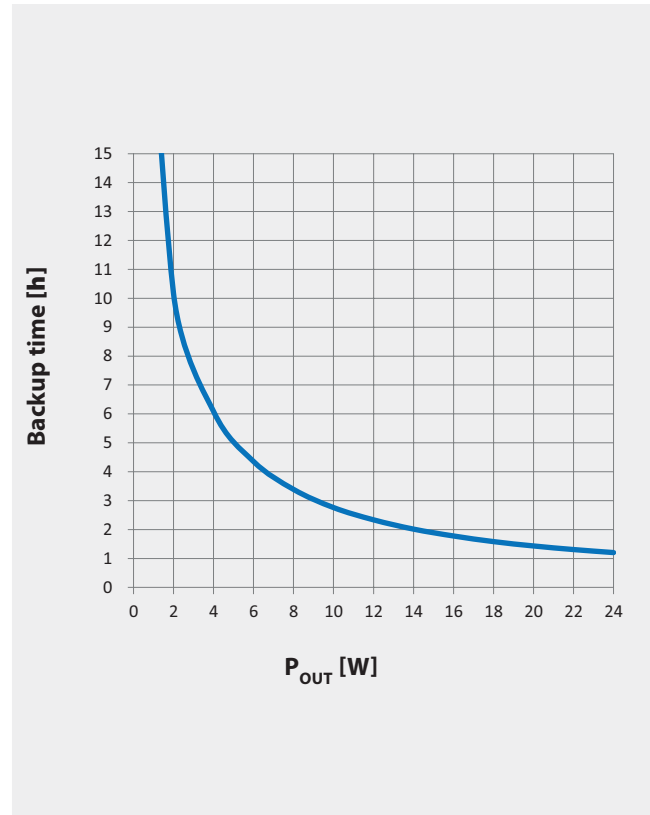
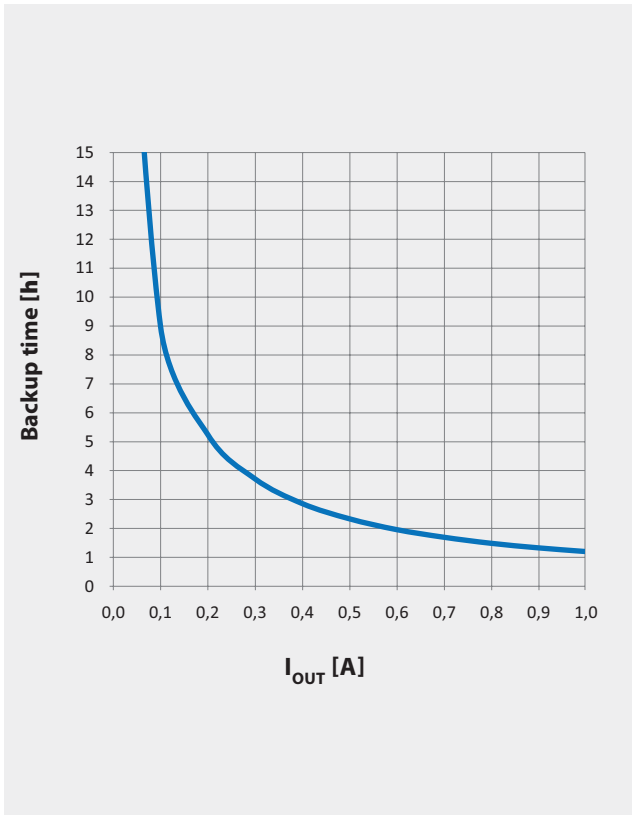

*Backup time depends on battery capacitance, load and temperature. At very high or low temperatures a reduction of backup time occurs. Unless otherwise specified, the values apply to measurements at +25 °C

Derating UPSI-2406DP3

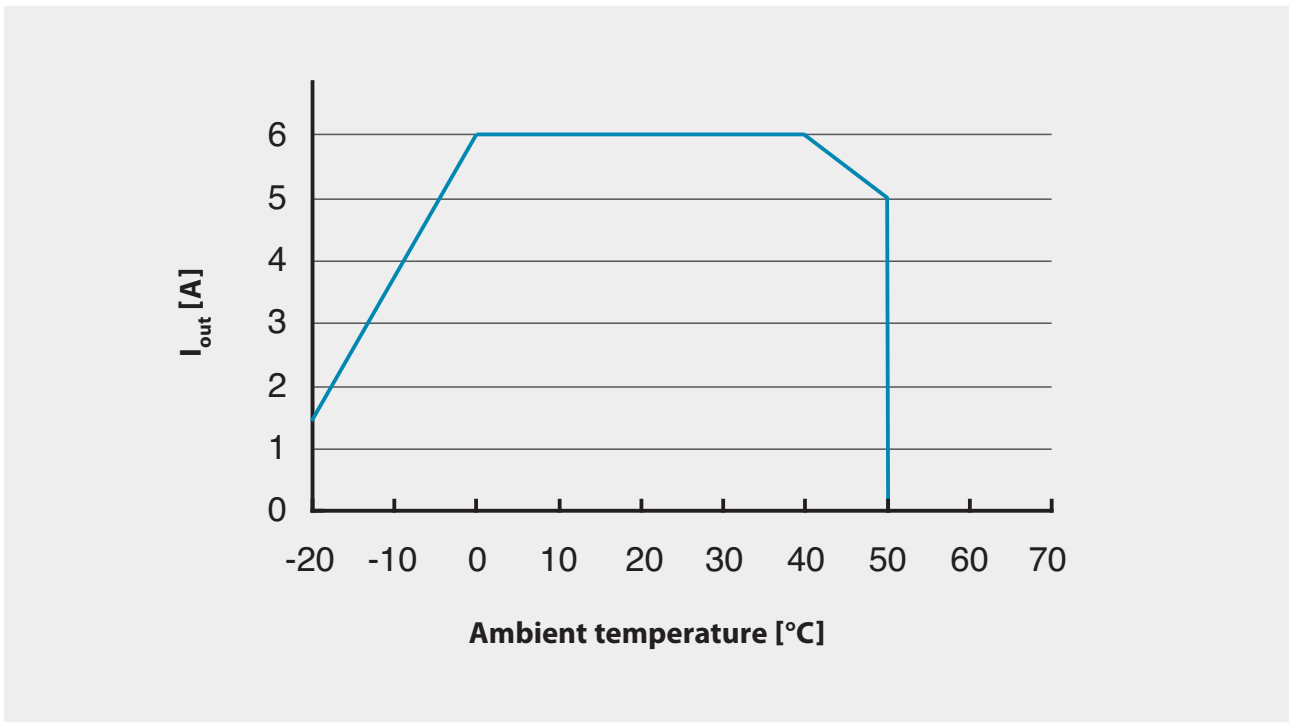

-20...0°C: At sub-zero temperatures, the charging time increases according to the physical properties of the cells (increased internal resistance).

A	Brief specification UPSI-2406DP1 / UPSI-2406DP2 / UPSI-2406DP3	3
B	Introduction and description	11
B1	Description of the product and its functions	11
B2	Intended use	12
B3	Software	12
C	Safety instructions	14
D	Technical Data	15
D1	General Technical Data	15
D2	Drawing	23
E	Name / Address / Support E-Mail / Phone number of the manufacturer	23
F	General Data	24
F1	Assembly and installation advice	24
F2	Convection and installation position	24
F3	Description of connectors	26
F4	Dimensioning the upstream power supply	28
F5	Connecting diagram	29
F6	Initial operation	30
F7	Overview connector / Counterpart with description / Scope of delivery	30
F8	Charging time	30
F9	Reverse polarity / Overcurrent / Short circuit	31
F10	Backup time in battery mode	31
F11	Behaviour in case of exceeding maximum backup time	31
F12	Dynamic Powerboost	32
F13	Status LED	34
F14	Shutdown diagram	35
F15	Recommendations for a long UPS service life	36
F16	Maintenance	36
F17	Disposal	36
F18	Disclaimer	36
F19	Preventive measures and rules when operating the UPS system	37

B Introduction and description

Read carefully before initial operation!

This manual shall help the user to get familiar with the product and its components and features. It shall provide information as accurately and completely as possible.

The manual as well as all documents has to be read and followed strictly before installation. Otherwise in certain situations warranty and guarantee can be cancelled partly or completely. Any liability on the part of Bicker Elektronik is excluded for possible existing errors as well as non-compliance with the instructions for use and installation.

B1 Description of the product and its functions

The UPSI-2406DP1, UPSI-2406DP2 and UPSI-2406DP3 (hereinafter also called UPS) are DC/DC UPS systems with numerous digital features and high performance. The UPS combines the UPSI-2406 with an integrated energy storage: The UPSI-2406DP1 uses an energy storage with Lithium-ion technology, the UPSI-2406DP2 uses an energy storage with supercap (also EDLCs) technology and the UPSI-2406DP3 uses an energy storage with LiFePO4 technology. The primary use of the UPS is to secure the supply during power failures and/or voltage fluctuations. The application which should be protected is connected to the output of the UPS.

The UPS requires a rated dimensioned power supply of 24VDC at the input. After the input voltage is applied, the UPS works in normal mode automatically. The input voltage is passed through to the output and the integrated energy storage device is charged simultaneously. The charging current depends dynamically on the load current at the UPS output. The green status LED lights up continuously when the UPS is in this state.

In the event of a voltage drop or a voltage fluctuation of the input voltage (below undervoltage limit), the UPS is switched to battery mode (also backup mode). In this state, the application at the UPS output is supplied via the energy storage device. The backup time (also buffer time) depends on the used energy storage, the value of the output current and the software settings of the UPS. An important feature is that the output voltage in battery mode is always regulated to 23.5VDC and does not decrease as the voltage of the energy storage device drops. If the UPS operates in battery mode, the status LED is slowly flashing (1 Hz flashing). When the UPSI-2406DP3 (with LiFePO4 battery) is used and it is discharged completely in battery mode, the recharging has to happen as soon as possible.

When the input voltage returns, the UPS is automatically switched back to normal mode and charging of the energy storage device is continued.

The UPS can also be used for user-initiated shutdowns of the supply voltage or cycles. Application examples are the replacement of larger batteries in vehicles in which the electronics should continue to be supplied, the opening and closing of safety valves after a malfunction or the shutdown of a system.

B2 Intended use

This device is designed to be installed into a suitable enclosure which protects against electrical, water and fire hazards and can then be used indoors and outdoors. It is primary built for being mounted on a DIN Rail and is intended for professional use in applications such as industrial control, communication and measurement technology. It must not be used in devices or equipment where a malfunction will cause serious injury or endanger human life.

B3 Software

Two different software solutions are available for the UPS Gen² devices, which should be selected depending on the operating mode or desired functions.

The models have the native UPS device group "HID Power Class" integrated via USB. Most operating systems recognize the UPS via Plug & Play as HID UPS or HID battery without additional drivers and can be operated with the operating system's own energy settings, which means self-sufficient operation without additional software. In this scenario, only the UPS Gen² Configuration Software is required to configure the internal UPS parameters.

If more functions are required, such as running a script before shutdown, the "UPScom - UPS Management Software" is the right choice. Unlike the "UPS Gen² Configuration Software", this is permanently installed and started on the system.

UPS Gen2 Configuration Software

The UPS Gen² Configuration Software is used for setting parameters and programming new firmware for all UPSI Gen² devices under Microsoft® Windows. The software tool also shows the operating status of the UPS and its energy storage and can be connected to the device via USB.

The UPS Gen2 software tool provides additional setting options in HID power mode, such as time-bound shutdown and other important functions.

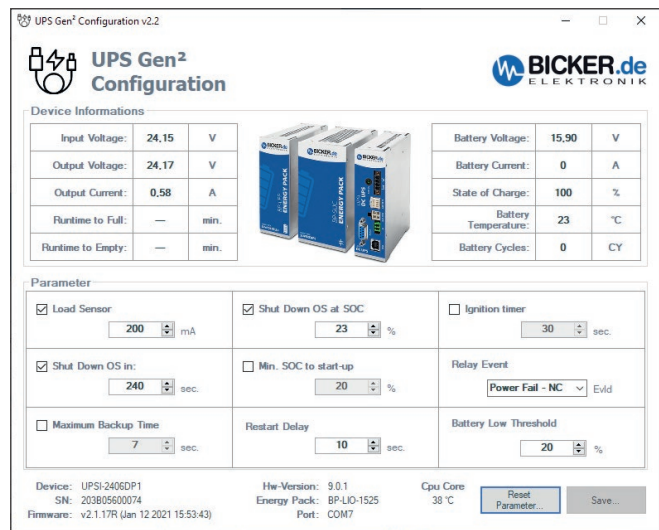

DOWNLOAD
UPS Gen2 Configuration Software

DOWNLOAD
User Manual

UPScom - UPS Management Software

During a power fail, the “UPScom” software enables controlled shutdown and switch off of connected equipment to prevent data loss or corruption. The responsive WEB UI is called up in a web browser to set and pre-program all parameters of the DC UPS system as well as for real-time monitoring with a display of the charge status.

Adjustable parameters include load sensor (mA), shutdown delay, maximum backup time, minimum load capacity before system start, email notifications and running scripts or programs before the system shuts down.

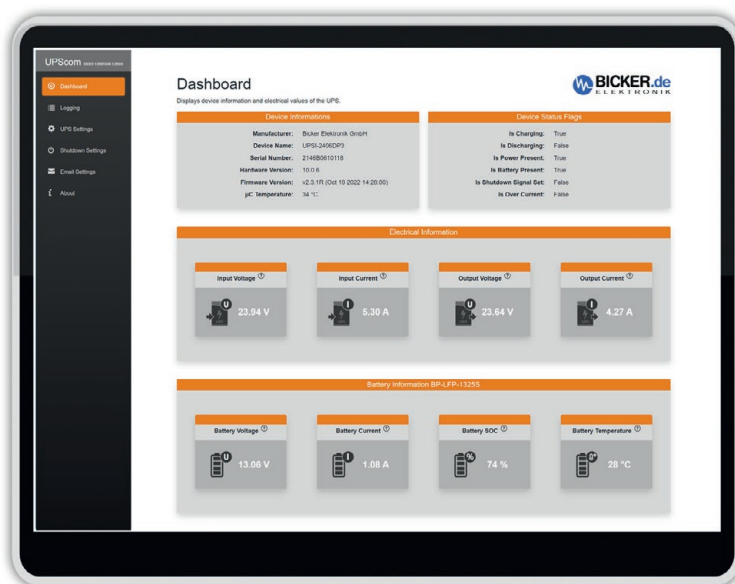

DOWNLOAD
UPScom for Windows® – All CPU

DOWNLOAD
UPScom for Linux – All CPU

C Safety instructions



WARNING!

Disregarding of following issues can result in electric shock, fire, serious injury or death.

1. Care must be taken to ensure proper and professional wiring.
2. The device pack must not be exposed to fire and temperatures outside the specification.
3. The device must not be immersed in water or exposed to splash water.
4. The device must not be operated in a humid environment or in an environment where dew and condensation are to be expected.
5. The device must not be opened, short-circuited, reversed, overheated or otherwise soldered/ welded.
6. Changes or attempts to repair the device are to be omitted.
7. Effects of foreign objects on the device must be avoided (e.g. metal parts).
8. Do not put obviously damaged devices into operation (e.g. dents, burn marks, rough contamination).
9. Keep ventilation openings clear.
10. Device must not be dropped.
11. All parts of the device and accessories must not be eaten or swallowed.
12. A current limited source is to be used. The required current values for the UPS are described in this manual.
13. The UPS is supplied with voltage from both the input source and the energy storage. The latter is still energized even after the input source has been disconnected.



ATTENTION!

1. Improper use and opening of the device will void the warranty.
2. The device may only be used as intended.
3. The national accident prevention and safety regulations must be observed.
4. The assembly of the device and the electrical installation have to be state of the art.
5. The electrical, thermal and mechanical limit values have to be observed.
6. The UPS wiring specifications - as described in this manual - have to be followed.

D Technical Data

D1 General Technical Data

INPUT DATA			
Unless otherwise stated, all specifications apply to 25°C ambient temperature, 24 V DC input voltage and nominal output current (I_N).			
	UPSI-2406DP1	UPSI-2406DP2	UPSI-2406DP3
Input voltage	24 VDC		
Input voltage range	22.5 VDC...30 VDC		
Electric strength max.	35 VDC		
Fixed connect threshold			
Undervoltage	22.5 VDC		
Voltage drop Input/Output	0.5 VDC max. (depending on load)		
Current consumption	UPSI-2406DP1	UPSI-2406DP2	UPSI-2406DP3
I_N ($U_{N'} I_{OUT} = I_{N'} I_{CHARGE} = 0$)	4.1 A	4.1 A	6.1 A
I_{MAX} ($U_{N'} I_{OUT} = I_{N'} I_{CHARGE} = \max$)	4.8 A	4.8 A	6.2 A
I_{DYN} ($U_{N'} I_{OUT} = I_{DYN.BOOST'} I_{CHARGE} = 0$)*	4.1...6.1 A	4.1...6.1 A	6.1...8.1 A
$I_{NO-LOAD}$ ($U_{N'} I_{OUT} = 0, I_{CHARGE} = 0$)	<100 mA	<100 mA	<100 mA
I_{CHARGE} ($U_{N'} I_{OUT} = 0, I_{CHARGE} = \max$)	1.8 A	1.5 A	1.8 A
Power consumption			
P_N ($U_{N'} I_{OUT} = I_{N'} I_{CHARGE} = 0$)	98.5 W	98.5 W	146.5 W
P_{MAX} ($U_{N'} I_{OUT} = I_{N'} I_{CHARGE} = \max$)	115 W	115 W	150 W
P_{DYN} ($U_{N'} I_{OUT} = I_{DYN.BOOST'} I_{CHARGE} = 0$)*	98.5...146.5 W	98.5...146.5 W	146.5...194.5 W
P_{CHARGE} ($U_{N'} I_{OUT} = 0, I_{CHARGE} = \max$)	43 W	36 W	43 W
Internal input fuse	Yes (15 A)		
Switch-on time	<5 sec		
Switch-on time battery start (BS)	n.a.		

*Max. 58 sec., depending on output power (see for that „F12 Dynamic Powerboost“)

OUTPUT DATA – NORMAL MODE

Unless otherwise stated, all specifications apply to 25 °C ambient temperature, 24 V DC input voltage and nominal output current (I_N).

	UPSI-2406DP1	UPSI-2406DP2	UPSI-2406DP3
Output voltage	24 VDC		
Output voltage range	$U_{OUT} = U_{IN} - 0.5$ VDC max. (depending on load)		
Capacitive load	3000 μ F (at start, 0 A load)		
Output current	UPSI-2406DP1	UPSI-2406DP2	UPSI-2406DP3
I_N	4 A	4 A	6 A
$I_{DYN.BOOST}^*$	4...6 A	4...6 A	6...8 A
I_{SFB}	30 A (5 ms)	30 A (5 ms)	30 A (5 ms)
Output power			
$P_N (U_N, I_{OUT} = I_N, I_{CHARGE} = 0)$	96 W	96 W	144 W
$P_{DYN.BOOST} (U_N, I_{OUT} = I_{DYN.BOOST}, I_{CHARGE} = 0)^*$	96...144 W	96...144 W	144...192 W
Overcurrent shutdown	4...6 A for max. 58 sec*; 6...10.8 A for max. 100 ms; >10.8 A for max. 5 ms		6...8 A for max. 58 sec*; 8...10.8 A for max. 100ms; >10.8 A for max. 5 ms
Short-circuit proof	Yes		
No-load proof	Yes		

OUTPUT DATA – BATTERY MODE

Unless otherwise stated, all specifications apply to 25 °C ambient temperature, 24 V DC input voltage and nominal output current (I_N).

	UPSI-2406DP1	UPSI-2406DP2	UPSI-2406DP3
Output voltage	24 VDC		
Output voltage range	$U_{OUT} = U_{IN} - 0.5$ VDC max. (depending on load)		
Output current	UPSI-2406DP1	UPSI-2406DP2	UPSI-2406DP3
I_N	4 A	4 A	6 A
$I_{DYN.BOOST}^*$	4...6 A	4...6 A	6...8 A
I_{SFB}	30 A (5 ms)	30 A (5 ms)	30 A (5 ms)
Output power			
$P_N (U_N, I_{OUT} = I_N, I_{CHARGE} = 0)$	94 W	94 W	141 W
$P_{DYN.BOOST} (U_N, I_{OUT} = I_{DYN.BOOST}, I_{CHARGE} = 0)^*$	94...141 W	94...141 W	141...188 W
Overcurrent shutdown	4...6 A for max. 58 sec*; 6...10.8 A for max. 100 ms; >10.8 A for max. 5 ms		6...8 A for max. 58 sec*; 8...10.8 A for max. 100ms; >10.8 A for max. 5 ms
Short-circuit proof	Yes		
No-load proof	Yes		
Switching time normal mode \gg battery mode	<600 μ s		

*Max. 58 sec., depending on output power (see for that „F12 Dynamic Powerboost“)

ENERGY STORAGE UPSI-2406DP1	
Charging method	CC / CV / CP
Nominal voltage U_N	14.8 V
End-of-charge voltage	15.9 V
Battery charge current	1 C max.
Undervoltage protection	10.8 V
Battery technology	Lithium-Ion
Nominal capacity	2.5 Ah / 37 Wh
Charging time ($I_{CHARGE} = \text{max}$)	App. 55 min
Buffer time (at $I_{OUT} = 4 \text{ A}$)	App. 12 min

ENERGY STORAGE UPSI-2406DP2	
Charging method	CC / CV / CP
Nominal voltage U_N	8.3 V
End-of-charge voltage	8.3 V
Battery charge current	16 A max.
Undervoltage protection	4.5 V
Battery technology	EDLC (Supercap)
Nominal capacity	5.73 kJ (3.88 kJ useful) / 1.59 Wh (1.08 Wh useful)
Charging time ($I_{CHARGE} = \text{max}$)	App. 4 min 30 sec
Buffer time (at $I_{OUT} = 4 \text{ A}$)	App. 30...35 sec

ENERGY STORAGE UPSI-2406DP3	
Charging method	CC / CV / CP
Nominal voltage U_N	13.2 V
End-of-charge voltage	13.8 V
Battery charge current	$\leq 2 \text{ C}$ (4.5...5 A)
Undervoltage protection	As soon as the first cell reaches 2.5 V
Battery technology	LiFePO4
Nominal capacity	2.5 Ah / 33 Wh
Charging time ($I_{CHARGE} = \text{max}$)	App. 60 min
Buffer time (at $I_{OUT} = 6 \text{ A}$)	App. 11 min

CONNECTION DATA INPUT / OUTPUT

Connection method	Screwable plug connector
Conductor cross-section solid	0.129 mm ² ... 1.31 mm ² (26 ... 16 AWG)
Conductor cross-section flexible	0.129 mm ² ... 1.31 mm ² (26 ... 16 AWG)
Conductor cross-section with ferrule	0.129 mm ² ... 1.31 mm ² (26 ... 16 AWG)
Stripping length	6 mm ... 7 mm
Tightening torque	0.3 Nm ... 0.4 Nm

CONNECTION DATA – RELAY

Connection labeling	RL
Switch contact (potential free)	Relay
Status (configurable)	Power Fail Alarm
Switching voltage	24 VDC / 125 VAC
Current carrying capacity	1 A (DC) / 0.5 A (AC)
State - signal assignment	NO (Normally Open) / NC (Normally Closed) – configurable via Software (see UPS Gen ² software manual)
Connection method	Lockable plug connector
Conductor cross-section solid	0.205 mm ² ... 1.3 mm ² (24 ... 16 AWG)
Conductor cross-section flexible	0.205 mm ² ... 1.3 mm ² (24 ... 16 AWG)
Conductor cross-section with ferrule	0.205 mm ² ... 1.3 mm ² (24 ... 16 AWG)
Stripping length	7 mm ... 9 mm
Switching time	1500 ms max.

DATA INTERFACE – USB

Interface designation	USB
Numbers of interfaces	1
Connection method	USB type B (female)
Locking	No
Transmission physics	USB 2.0
Topology	Point-to-point
Protocol	VCOM, HID
Transmission length	≤3 m
Access time	<1 s
Chipset	NXP
Electrical isolation	No

DATA INTERFACE – RS232	
Interface designation	RS232
Numbers of interfaces	1
Connection method	DSUB 9-Pin (female)
Locking	No
Transmission physics	RS232 light (TX / RX)
Topology	Point-to-point
Symbol rate (baud rate)	38400
Type of cable	1:1
Transmission length	≤10 m
Access time	< 1 s
Voltage level	-6 VDC ... +6 VDC
Electrical isolation	No

GENERAL DATA	
Flammability class according to UL 94 (housing / terminal blocks)	V0
Weight	DP1 / DP2: 0.6 kg, DP3: 0.8 kg
UPS connection in parallel	No
UPS connection in series	No

HOUSING	
Degree of protection	IP 20
Protection class	III (without PE)
Mounting type	DIN-Rail mounting (EN 60715)
Housing version	Aluminium
Dimension W / H / D	63 mm / 120 mm / 100 mm (without front connectors and DIN-Rail mounting bracket)

ENVIRONMENTAL CONDITIONS	
Ambient temperature (operation)	DP1: 0...+50 °C / DP2: -20... +65 °C / DP3: -20... +50 °C
Ambient temperature (start up without load)	DP2: -30 °C
Ambient temperature (storage / transport)	DP1: -20...+50 °C / DP2: -30...+65 °C / DP3: -30...+55 °C
Max. permitted humidity	≤95 % (at +25 °C, no dew)
Operating altitude	≤4000 m
Climate class	3k3 (EN 60721)
Degree of pollution	2
Overvoltage category	
EN 61010-1	I
EN 61010-2-201	I
Indoor / Outdoor use	Yes / Yes (in housing)

STANDARDS	
Safety extra-low voltage	IEC 61010-1 (SELV) IEC 61010-2-201

APPROVALS (UPSI-2406DP1 and UPSI-2406DP2)	
UL	ETL, UL61010-1 ETL, UL61010-2-201
CSA	CSA C22.2 61010-1-12 CSA C22.2 61010-2-201
CB Scheme	IEC 61010-1 IEC 61010-2-201

APPROVALS (UPSI-2406DP3)	
UL	n.a. (possible upon consultation)
CSA	
CB Scheme	

INTERFERENCE IMMUNITY ACCORDING TO EN 61000 (INDUSTRY)	
Basic standard CE	Fulfilled requirements according to EN 61000 (CE) (Interference immunity of industrial environment)
Electrostatic discharge EN 61000-4-2 Contact discharge Air discharge Comment	4 kV 8 kV Criterion B
Electromagnetic HF field EN 61000-4-3 Frequency range Test field strength Frequency range Test field strength Comment	80 MHz ... 1 GHz 10 V/m 1.4 GHz ... 2 GHz 3 V/m Criterion A
Fast transients (Burst) EN 61000-4-4 Test voltage Comment	2 kV Criterion A
Surge voltage load (Surge) EN 61000-4-5 Test voltage L-N Test voltage L-PE, N-PE Comment	±0.5 kV ±1 kV Criterion A
Power frequency magnetic field immunity EN 61000-4-8 Test level Comment	30 A/m Criterion A

EMISSION ACCORDING TO EN 55016-2-3 (DOMESTIC)	
Basic standard CE	Fulfilled requirements according to EN 55016-2-3 (CE) (Domestic)
Conducted emission from the power port EN 55016-2-3 Frequency range Comment	150 kHz–30 MHz Conform
Electric field radiated emission EN 55016-2-3 Frequency range Comment	30 MHz–1 GHz Conform

LEGEND	
Criterion A	Normal operating behaviour within the defined limits.
Criterion B	Temporary impairment of the operating behaviour, that is corrected by the device itself.

D2 Drawing

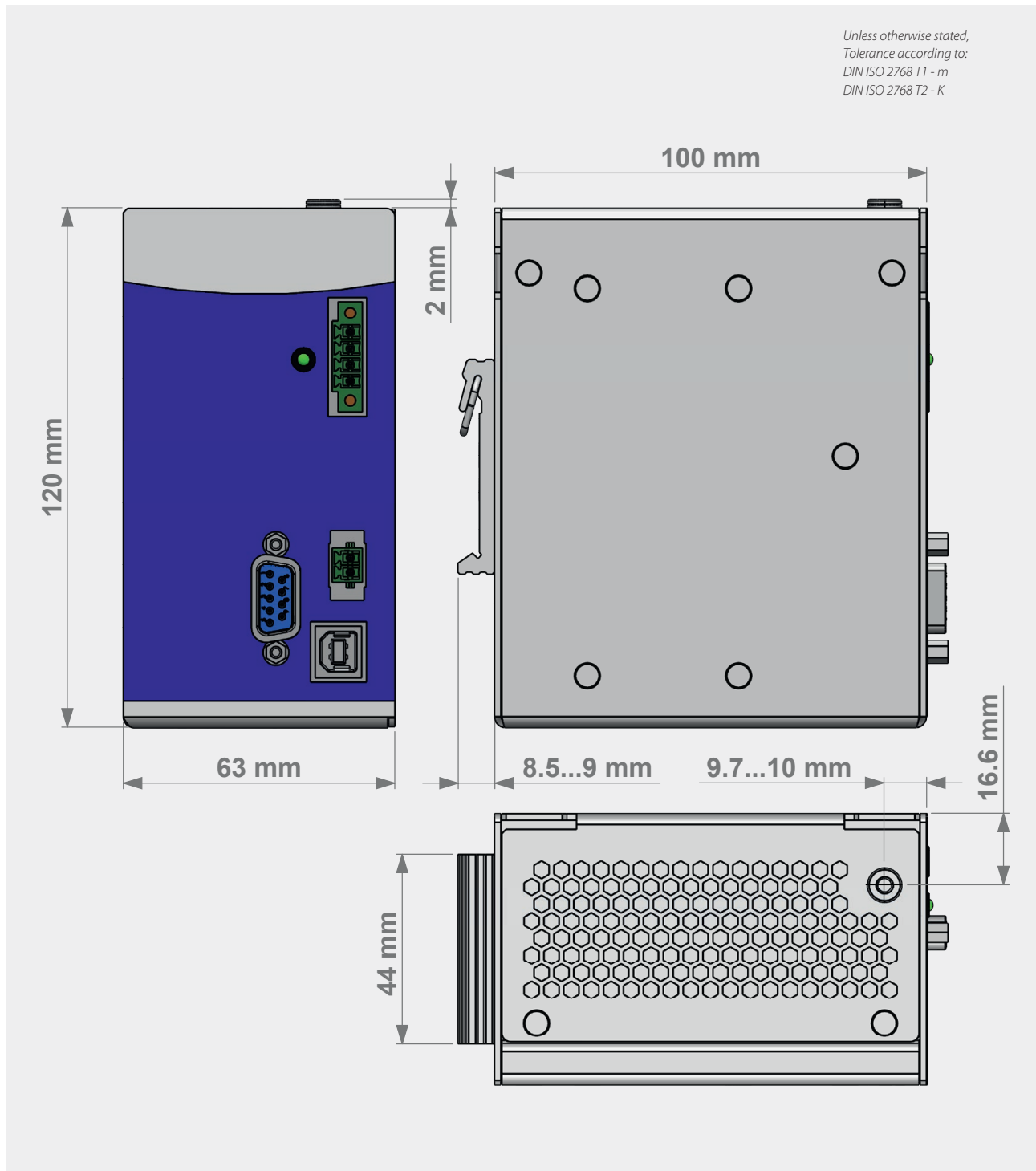

E Name / Address / Support E-Mail / Phone number of the manufacturer

Bicker Elektronik GmbH · Ludwig-Auer-Straße 23 · 86609 Donauwörth · Germany

E-Mail: support@bicker.de · Tel.: +49 (0) 906 70595-0

F General Data

F1 Assembly and installation advice



Installation and operation of this device is only allowed to be executed by a qualified electrician! The application has to be separated from any power during the mounting process. Wires have to be connected safely and must not have contact with sharp edges. Pay attention to correct polarity! Before commissioning, check all the connections for correctness!

F2 Convection and installation position

For these DIN rail versions, vertical mounting on a horizontal rail (DIN rails according to EN 60715) is recommended in order to achieve the best possible convection of the UPS. Another mounting position is possible, but operation up to the respective highest ambient temperature can not be guaranteed.

Make sure that no ventilation holes are covered by other, neighboring components and devices.

The following distances to neighboring devices are recommended:

Left / right: 20 mm

Top / bottom: 50 mm



The devices comply with the IP protection class 20.

DIN-Rail mounting and DIN-Rail profile according to EN 60715

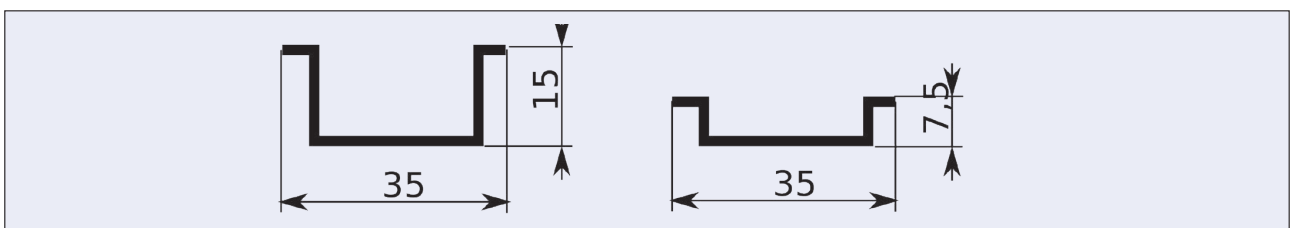
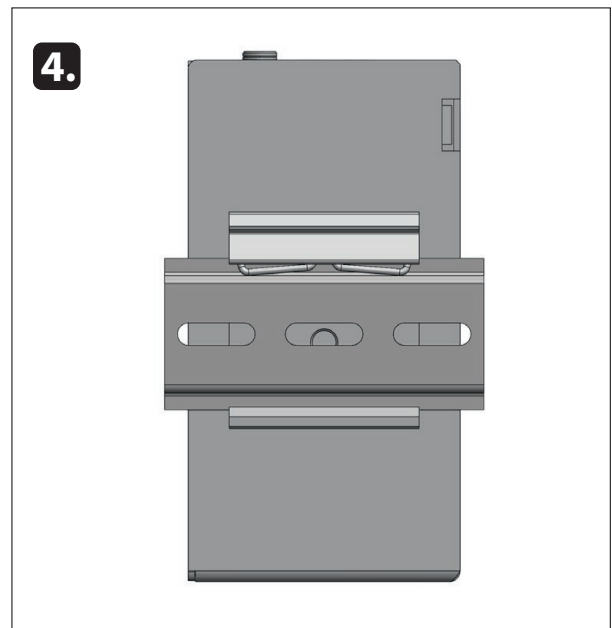
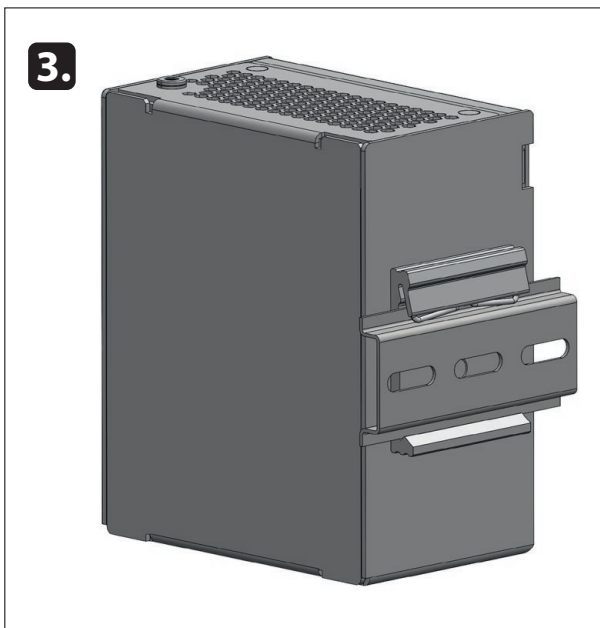
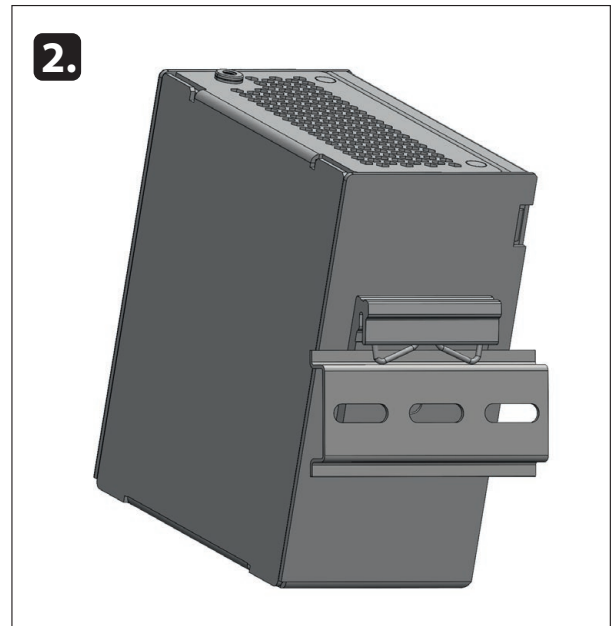
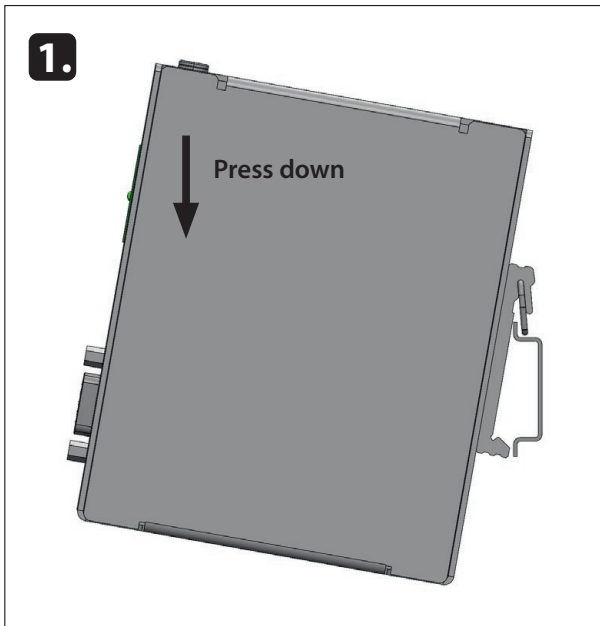

F3 Description of connectors

INPUT & OUTPUT (IN & OUT)

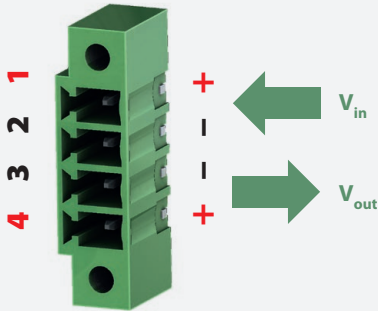

PIN	FUNCTION
1	Vin +
2	Vin -
3	Vout -
4	Vout +

RELAY CONNECTION (RL)

The function of the relay connection is configurable via software. When closing the relay the resistor value between both contacts is approx. 0 Ω, otherwise they are „open load“.

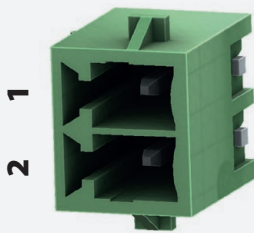

PIN	FUNCTION
1	Relay contact 1
2	Relay contact 2

RS-232

To enable PIN 9, PIN 1 has to be permanently switched to PIN 5 (GND).



PIN	FUNCTION
1	PIN 9 ENABLE
2	TXD
3	RXD
4	DSR
5	GND
6	DTR
7	NC
8	NC
9	+5V (4.9V at 20 mA / 4.6 V at 50 mA)

FUNCTIONAL EARTH (FE) 

There is a screw attachment (M4 thread, screw M3x6mm max.) at the front right corner on top of the device to connect functional earth if required. The requirements for interference emission EN55016-2-3 (see D1 General Technical Data) are only met if this connection is connected.

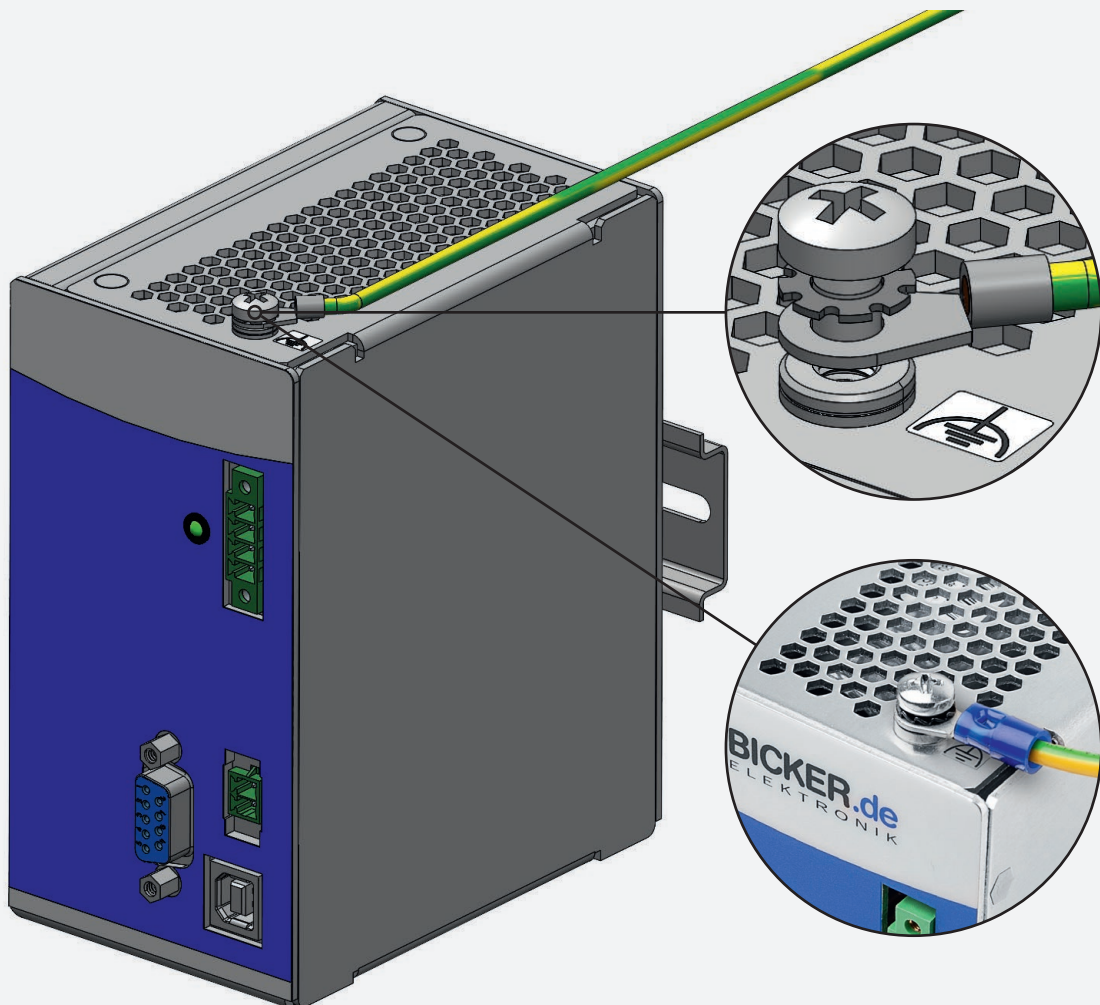

F4 Dimensioning the upstream power supply

Ensure that the upstream power supply is correctly dimensioned to guarantee the charging process of the batteries and the correct functioning of the application. The input has to be supplied from a SELV or PELV power supply. In order to operate the UPS device with complete functionality, **no** constant current function should be used and the upstream power supply should be able to provide at least the following values:

- UPSI-2406DP1 and DP2: 24 V / 5 A (120 W)
- with Powerboost function: 24 V / 6.25 A (150 W)
- UPSI-2406DP3: 24 V / 6.25 A (150 W)
- with Powerboost function: 24 V / 8.25 A (~200 W)

If less load than the maximum load is required at the output, the voltage supply can be dimensioned according to the tables below (column 3).

UPSI-2406DP1		
I_{LOAD} [A]	I_{CHARGE} [A]	I_{IN-MIN} [A]
0	1.8	2
1	1.5	2.5
2	1.3	3.5
3	1	4
4	0.8	5

UPSI-2406DP2		
I_{LOAD} [A]	I_{CHARGE} [A]	I_{IN-MIN} [A]
0	1.5	1.5
1	1.3	2.5
2	1.2	3.5
3	1	4
4	0.8	5

UPSI-2406DP3		
I_{LOAD} [A]	I_{CHARGE} [A]	I_{IN-MIN} [A]
0	1.8	2
1	1.5	2.5
2	1.3	3.5
3	1	4
4	0.8	5
5	0.5	5.5
6	0.2	6.25

F5 Connecting diagram

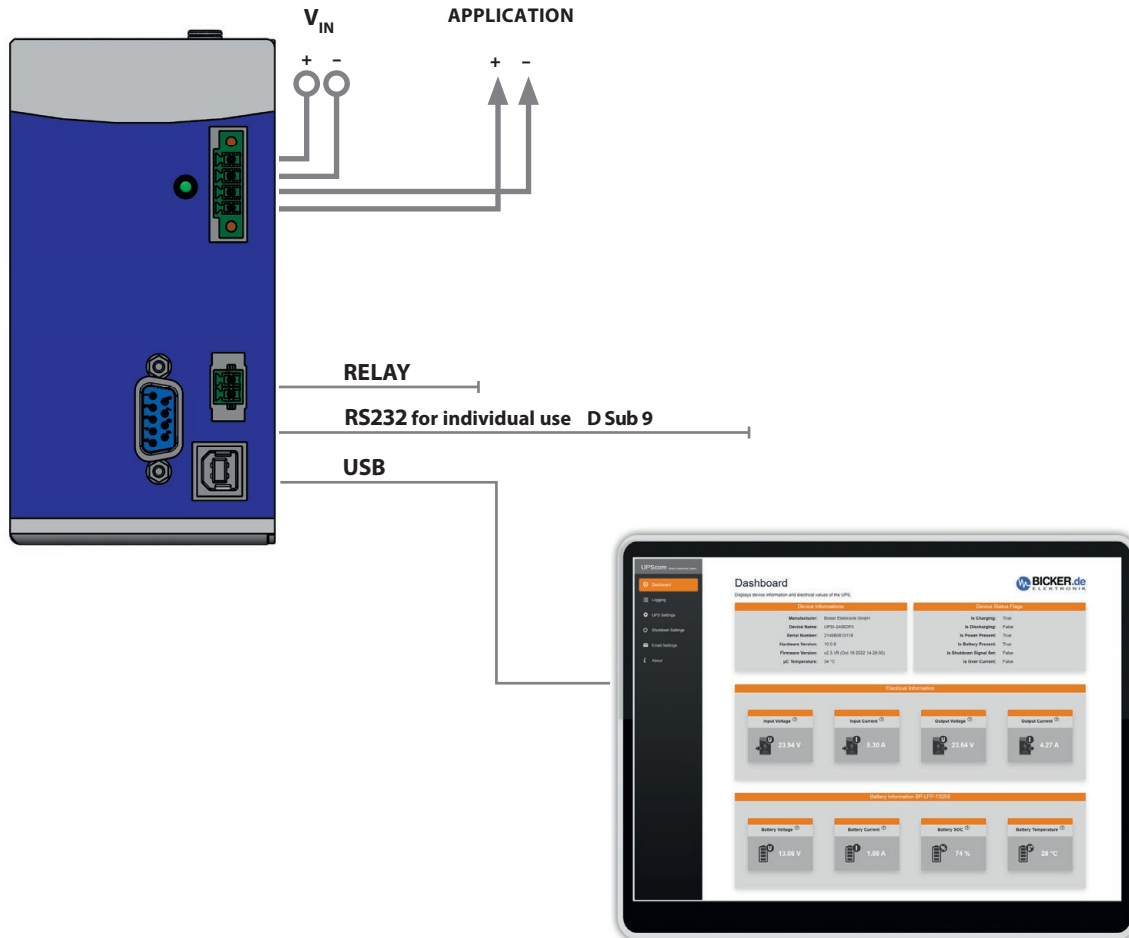

CONNECTING ORDER

1. APPLICATION (V_{OUT})
2. DC SOURCE (V_{IN})
3. RELAY / USB / RS232

Dismantling order reverse to connection!



V_{IN}/V_{OUT} - ATTENTION!

1. Note polarity!
2. AWG16 wire should be used (1.5 mm²)

F6 Initial operation

The correct installation of the UPS has to be ensured.

The start is accomplished by connecting the upstream power supply: When an input voltage higher than 22.5 V is connected to the input terminals, the energy storage gets queried and transmits its data. The UPS sets the corresponding end-of-charge voltage and releases the pack via the system present signal. After that, the charging of the energy storage starts.

The applied voltage at the input of the UPS is passed through to the output, reduced by a current-dependent voltage drop ($V_{OUT} = V_{IN} - 0.5 \text{ V}$ at maximum current). The device charges the energy storage and monitors the upstream voltage thresholds at the input (UPS function).

It must be ensured that the source supplies enough current to guarantee the charging process (see chapter F4 „Dimensioning the upstream power supply“).



Even after disconnecting the upstream source and also no voltage is measurable at the output, the UPS can be still powered by the energy storage.

F7 Overview connector / Counterpart with description / Scope of delivery

CONNECTOR	PART NO.	COUNTERPART NO.
V_{IN}/V_{OUT}	Würth Elektronik 691325310004	Würth Elektronik 691364300004
RL	Würth Elektronik 691305140002	Würth Elektronik 691304130002
USB	Würth Elektronik 61400416121	USB type B connector
RS232	D-Sub9 Female	D-Sub 9 Male

SCOPE OF DELIVERY	
QUANTITY	DESCRIPTION
1x device	UPSI-2406DP1 or UPSI-2406DP2 or UPSI-2406DP3 - DC UPS
1x	V_{IN} / V_{OUT} connector counterpart
1x	Relay connector counterpart

F8 Charging time

Charging times depend on energy storage, input voltage and the load current.

F9 Reverse polarity / Overcurrent / Short circuit

Reverse polarity:

The device has active reverse polarity protection at the input if the input terminal is connected with reverse polarity while the device is still switched off (e.g. during commissioning). If the device operates in battery mode and the input terminals are connected with reverse polarity, no reverse polarity protection is given.

Overcurrent:

If the load current at the output is too high, the device switches it off. For maximally allowed current values and peak current values refer to chapter D „Technical Data“. See for that chapter F12 „Dynamic Powerboost“. The status LED indicates the error status by means of a very rapid flashing sequence. A restart attempt occurs every 10 seconds in normal mode. During battery mode there is no restart attempt.

Short circuit:

In the event of a short-circuit at the output of the UPS, the output is immediately disconnected (<5 ms). The status LED indicates the error status by means of a very rapid flashing sequence. A restart attempt occurs every second in normal mode (non-latch). During battery mode there is no restart attempt. The impact of a short-circuit to the device depends on length and diameter (impedance) of the output wiring. In case of a short-circuit directly at the plugs a damage of the device can occur.

F10 Backup time in battery mode

The nominal backup times can be found within the technical data of this user manual or the user manuals/datasheets of the used energy storages. At extreme low or high temperatures a reduction of the nominal backup times can occur.

F11 Behaviour in case of exceeding maximum backup time

When the given buffering times are exceeded, the output is separated on the basis of the discharge voltage of the corresponding energy storage (total discharge protection).

With supercapacitors in particular, an additional switch-off threshold can take effect if the discharge current of the energy storage device is too high (>15 A). This can occur at very high load currents at the output of the UPS. The lower the voltage of the energy storage device decreases, the higher the discharge current so that a constant power is ensured at the output of the UPS.

If the allowable output current during battery mode exceeds more than 70%, the converter switches off first, without separating the output immediately. In this case, the voltage at the output of the UPS can drop significantly below 23.5 V. This condition should be avoided by shutting down the system in time.

F12 Dynamic Powerboost

Valid from firmware version 2.2.1

With the dynamic power boost function, it is possible to temporarily draw a higher output power (overload) from the UPS. As soon as an overload is detected when the threshold value is exceeded, this is possible in a dynamic overload range of up to 58 seconds, before the output is disconnected.

During operation, the device constantly measures the output energy drawn over the last 58 seconds (1 reading/second). This measured output energy is compared with the maximum possible output energy (DP1 and DP2: max. 5.57 kJ, DP3: max. 8.35 kJ). If the value is smaller, the device continues to run and the output remains unlocked. If the value is larger, the output is disconnected. The output energy will continue to be recorded and the output will not be released again until the value falls below the maximum value.

	UPSI-2406DP1 / UPSI-2406DP2	UPSI-2406DP3
Nominal output power ($I_{OUT\ Nominal} \times U_{OUT}$)	96 W	144 W
Threshold for detecting an overload	>96 W	>144 W
Range for dynamic overload	96...144 W	144...192 W
Maximum output energy ($P_{OUT\ Nominal} \times t$)	~ 5.57 kJ (5568 Ws) (96 W x 58 sec)	~ 8.35 kJ (8352 Ws) (144 W x 58 sec)

Note: The output power is determined by output current and output voltage. A current-dependent voltage drop can reduce the output voltage, which is why the output power varies in some cases.

Example 1 (UPSI-2406DP1 / UPSI-2406DP2)

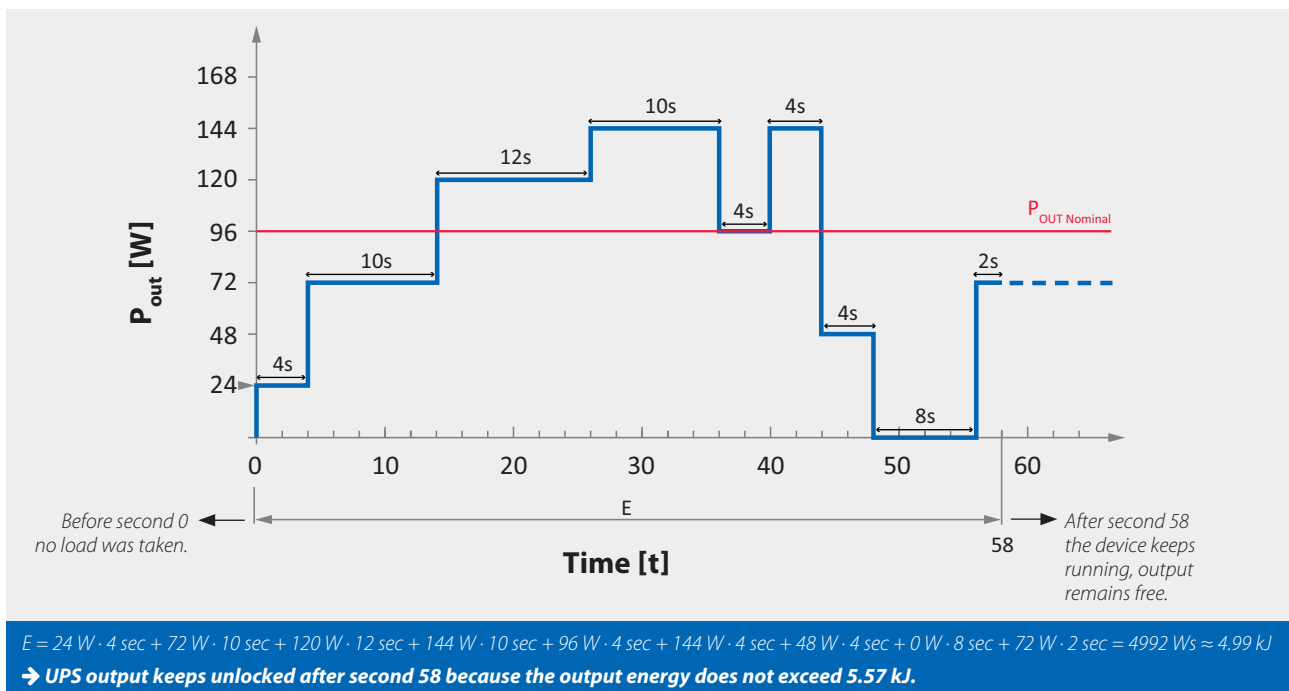

Example 2 (UPSI-2406DP1 / UPSI-2406DP2)

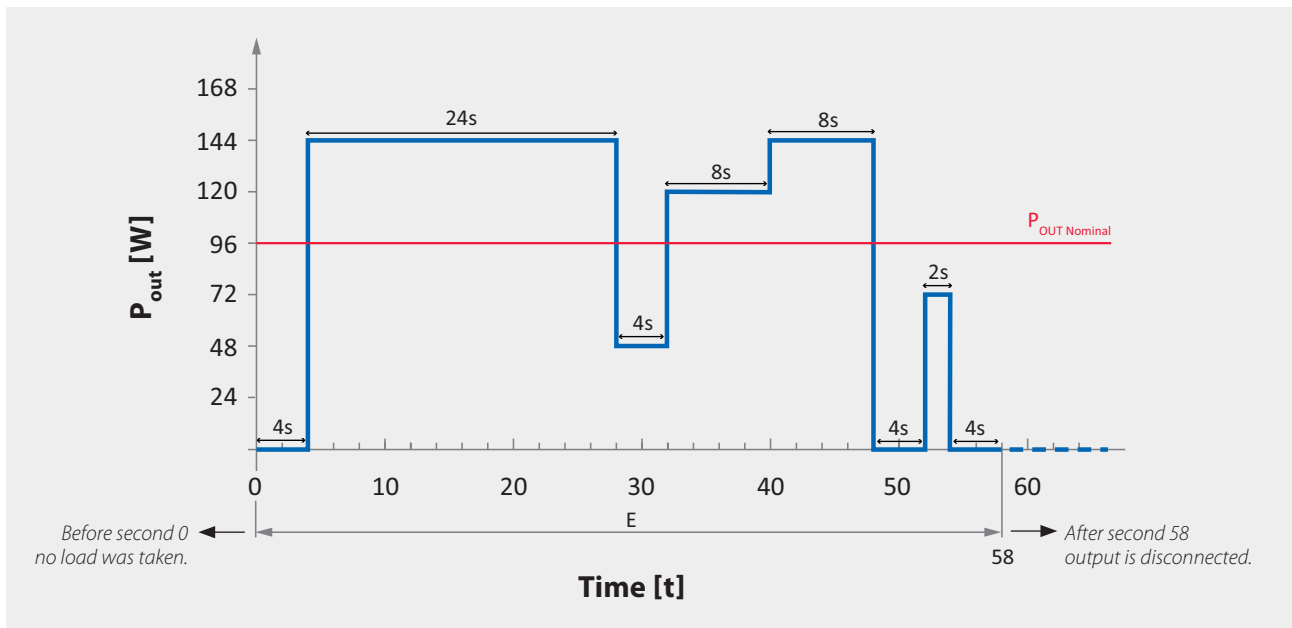

$E = 0\text{ W} \cdot 4\text{ sec} + 144\text{ W} \cdot 24\text{ sec} + 48\text{ W} \cdot 4\text{ sec} + 120\text{ W} \cdot 8\text{ sec} + 144\text{ W} \cdot 8\text{ sec} + 0\text{ W} \cdot 4\text{ sec} + 72\text{ W} \cdot 2\text{ sec} + 0\text{ W} \cdot 4\text{ sec} = 5808\text{ Ws} \approx 5.81\text{ kJ}$
→ UPS output is disconnected after 58 seconds because the output energy exceeds 5.57 kJ.

Example 3 (UPSI-2406DP3)

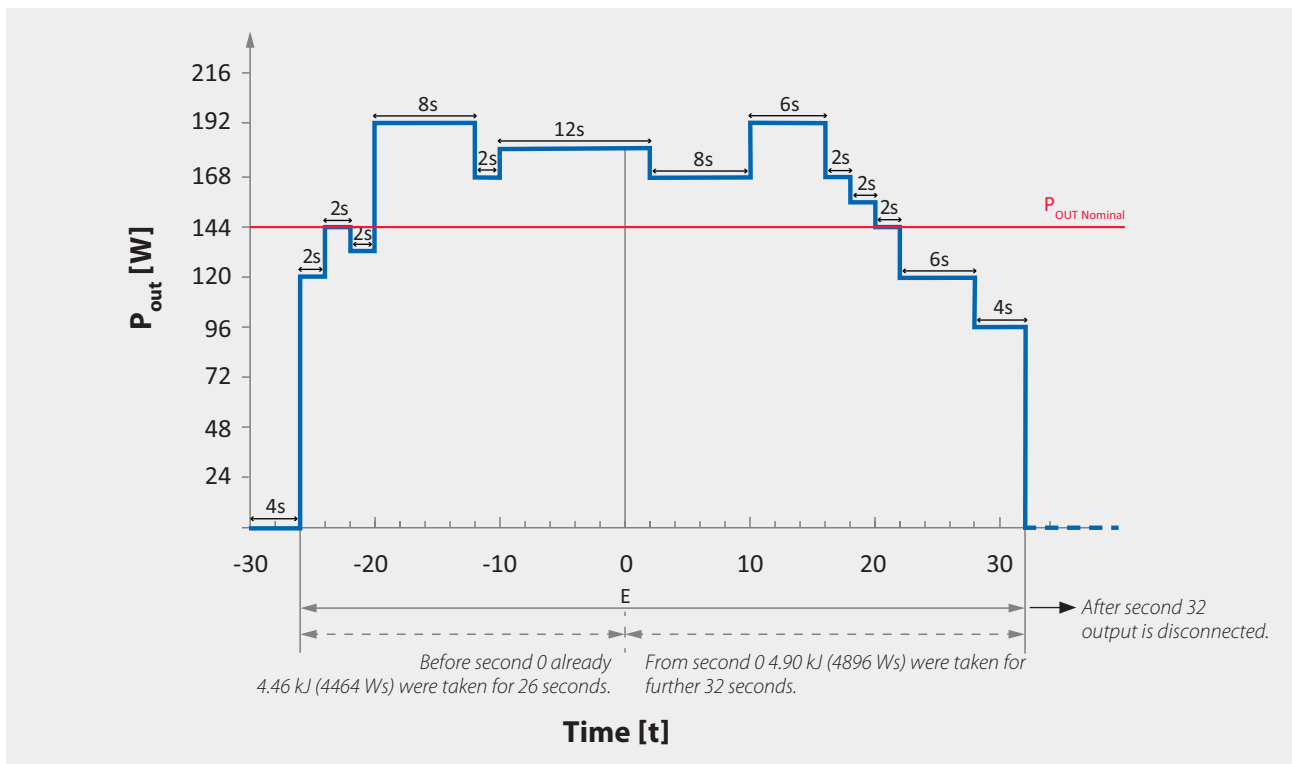

$E = 120\text{ W} \cdot 2\text{ sec} + 144\text{ W} \cdot 2\text{ sec} + 132\text{ W} \cdot 2\text{ sec} + 192\text{ W} \cdot 8\text{ sec} + 168\text{ W} \cdot 2\text{ sec} + 180\text{ W} \cdot 12\text{ sec} + 168\text{ W} \cdot 8\text{ sec} + 192\text{ W} \cdot 6\text{ sec} + 168\text{ W} \cdot 2\text{ sec} + 156\text{ W} \cdot 2\text{ sec} + 144\text{ W} \cdot 2\text{ sec} + 120\text{ W} \cdot 6\text{ sec} + 96\text{ W} \cdot 4\text{ sec} = 9360\text{ Ws} \approx 9.36\text{ kJ}$
→ UPS output is already disconnected after 32 seconds because the output energy (of the last 58 seconds) exceeds 8.35 kJ.

F13 Status LED

Valid from firmware version 2.1.19

MAIN STATES		
	Always on	Status: mains voltage >> Mains voltage is present.
	1 Hz flash (1 s on, 1 s off)	Status: Battery mode >> Mains voltage is not present.
INTERNAL STATES		
	1 x flash (LED is off briefly), pause 2 s	Status: Battery start* >> Manual start from the battery by pressing the BS button.
	2 x flash (LED is off briefly), pause 2 s	Status: Capacity not reached >> Capacity is required. Output is only activated when the battery is charged to set SOC.
	3 x flash (LED is off briefly), pause 2 s	Status: Shutdown >> UPS has received a shutdown signal and is waiting until the set load sensor value has fallen below.
	4 x flash (LED is off briefly), pause 2 s	Status: Reboot >> Output is deactivated and time until reboot runs (Reboot phase).
BATTERY FAILURES		
	1 x flash (LED is off a long time), pause 2 s	Status: No battery detected
	2 x flash (LED is off a long time), pause 2 s	Status: Battery overvoltage >> Charge voltage at battery is too high, battery is deactivated.
	3 x flash (LED is off a long time), pause 2 s	Status: Battery overcurrent >> Charge current at battery is too high, battery is deactivated.
	4 x flash (LED is off a long time), pause 2 s	Status: Battery temperature failure >> Battery temperature sensor was not detected or battery temperature is too high or low.
UPS FAILURES		
	Quick flashing without pause	Status: UPS failure >> Output current too low, UPS is deactivated. >> Overcurrent at output, output is deactivated >> Short circuit at output, output is deactivated >> Internal failure, UPS is deactivated.

* Not available for these versions

F14 Shutdown diagram

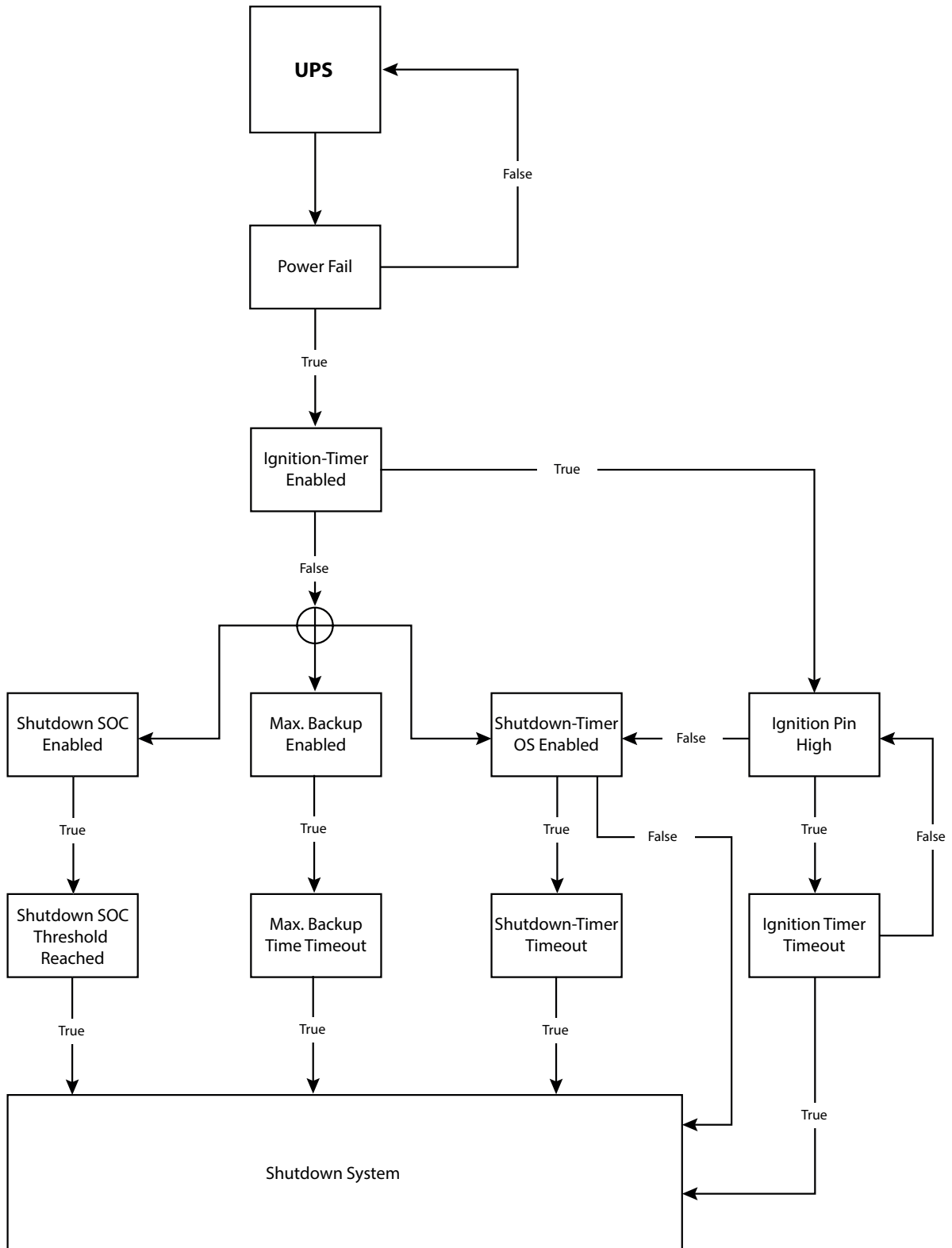

F15 Recommendations for a long UPS service life

Over time, the capacity of the Supercaps decreases and the ESR (equivalent series resistance) increases. However, EOL is often defined as a reduction in capacity to 70% and a doubling of the ESR. An important aspect for the aging of the Supercaps is the end-of-charge voltage and the operating temperature.

LiFePO₄ batteries also age over time depending on cycles, operating temperature and the level of the end-of-charge voltage. The end-of-charge voltages are optimized so that they are at an optimum between service life and performance.

To extend the lifetime of the system, the device should not be placed near sources of heat and should be placed within good air-circulation. When using the UPSI-2406DP3 (LiFePO₄ battery), a larger capacity than actually required should always be used. The less deep the packs are discharged, the longer the service life lasts.

F16 Maintenance

The UPS contains no serviceable parts. In case of a malfunction the upstream power source has to be disconnected and cables have to be removed. Use a dry cloth for cleaning!

F17 Disposal

Electric and electronic devices must not be disposed with domestic waste!
Please consider to each country's own regulation about recycling and disposal of used batteries at the end of their lifetime or resending to any recycling organization.



F18 Disclaimer

We, the Bicker Elektronik GmbH, have checked the contents of this document for compliance with the hardware and software described. Nevertheless, deviations can not be ruled out, so we assume no liability for the complete agreement. The information in this publication is checked regularly, necessary corrections are included in the updated versions.

Suggestions for improvement as well as tips and criticism are always welcome.

F19 Preventive measures and rules when operating the UPS system

The voltage drop of the supply line has to be kept in mind! The maximum charge current can cause huge voltage drops if too long supply lines are used. If the voltage drop is too high a shortfall of the threshold values is possible and a not intended Power Fail could be caused. With maximum load the voltage at the input of the device must not undercut 22.5V.

Even after the upstream supply has been disconnected, the device continues to run for some time after the shortfall of the load sensor (setting of a threshold value for current: currents below this value will be classified as „system off“ (no load)).

A short direct at the output of the device can cause damage or destruction of the UPS. In the event of a fault, electrolytes can escape in liquid and gaseous form.

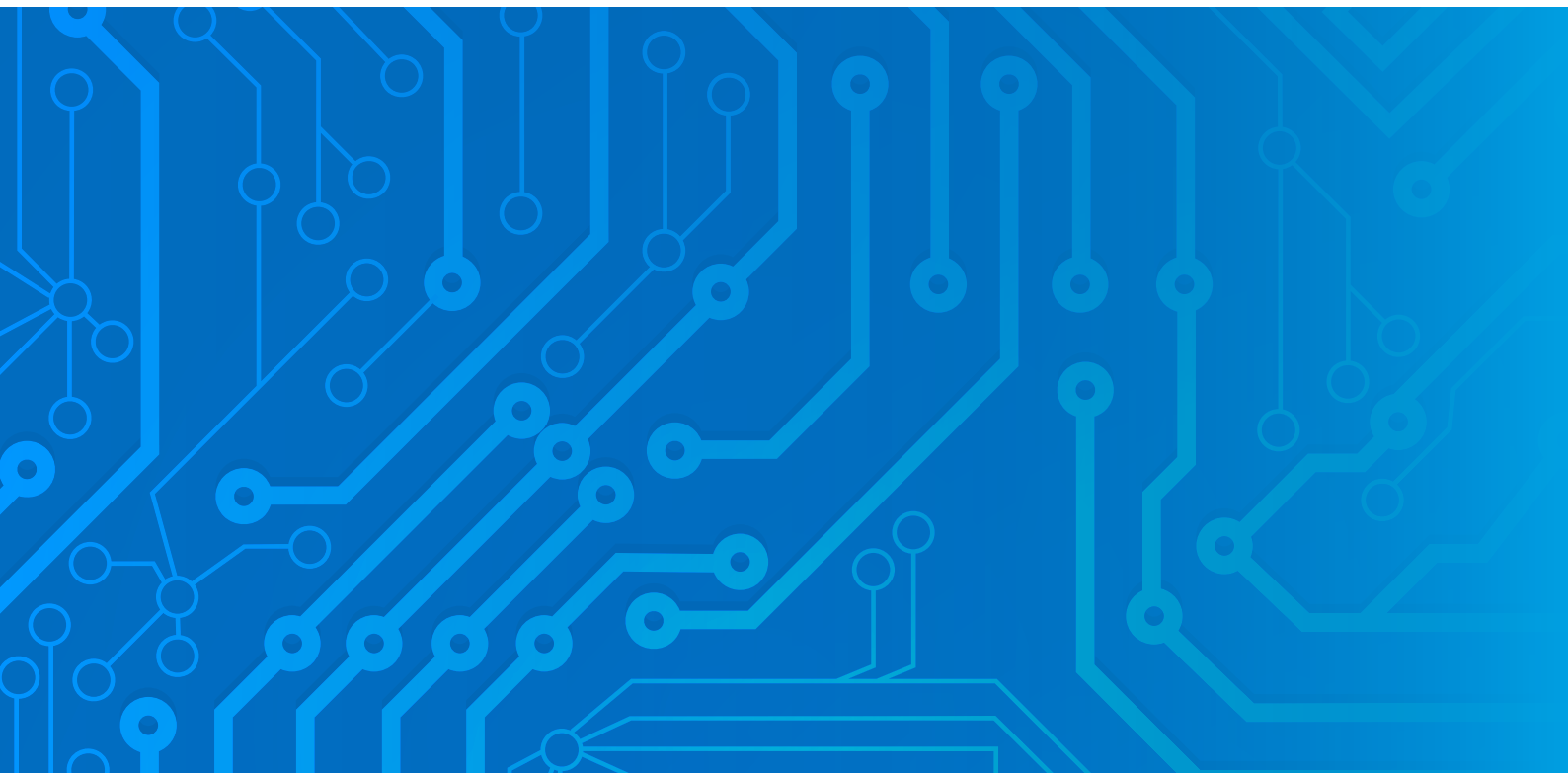

Note: Subject to errors and technical modifications!
Windows® is a registered trademark of the Microsoft Corp.
Status as at: 27.04.2023 – Revision 2-1



Bicker Elektronik GmbH
Ludwig-Auer-Straße 23
86609 Donauwörth · Germany
Tel. +49 (0) 906 70595-0
Fax +49 (0) 906 70595-55
E-Mail info@bicker.de
www.bicker.de