

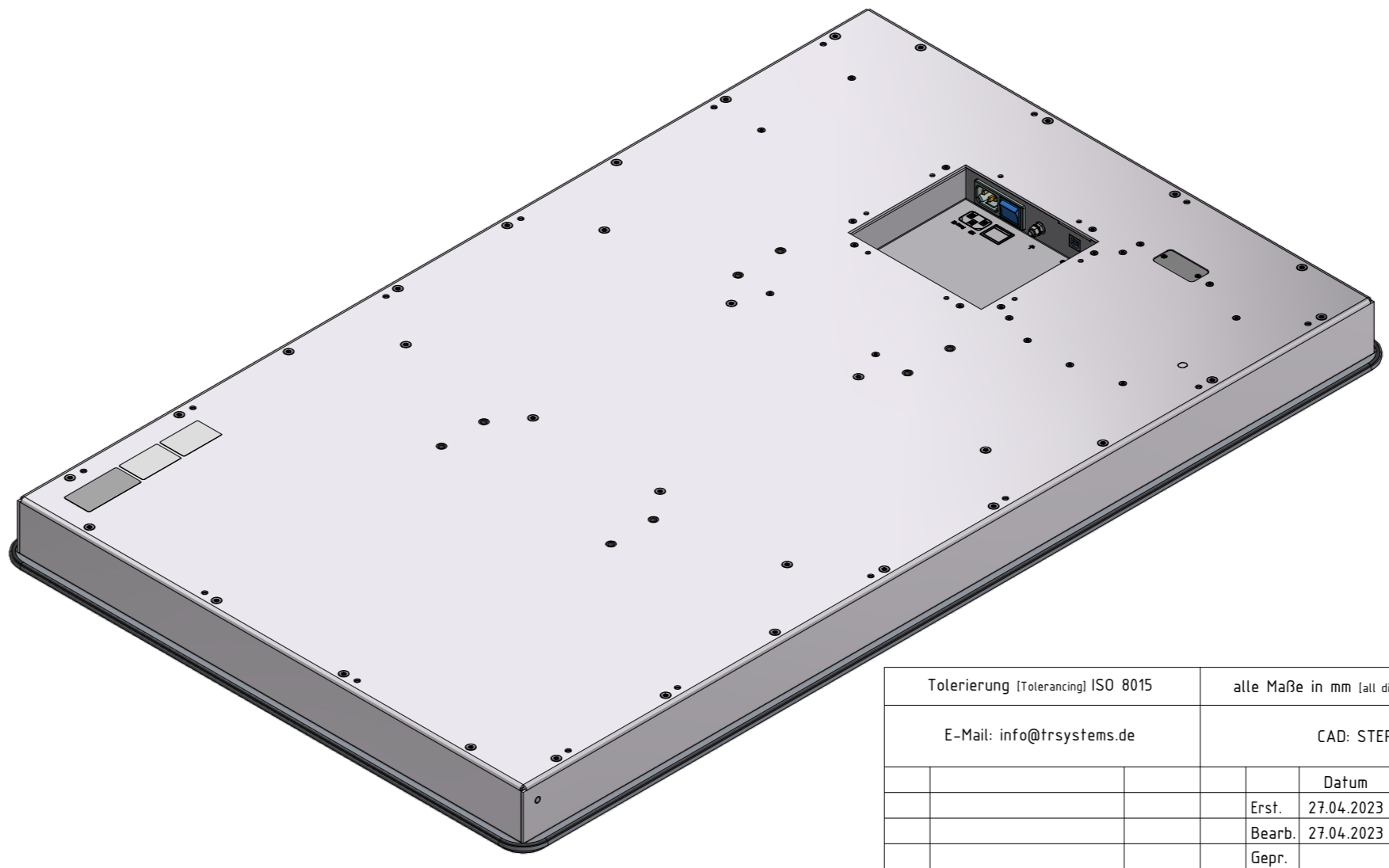

i Alle nicht tolerierten Maße sind Richtwerte. [All non-tolerated dimensions are guide values.]
 Technische Änderungen grundsätzlich vorbehalten. [We reserve the right to make technical changes.]

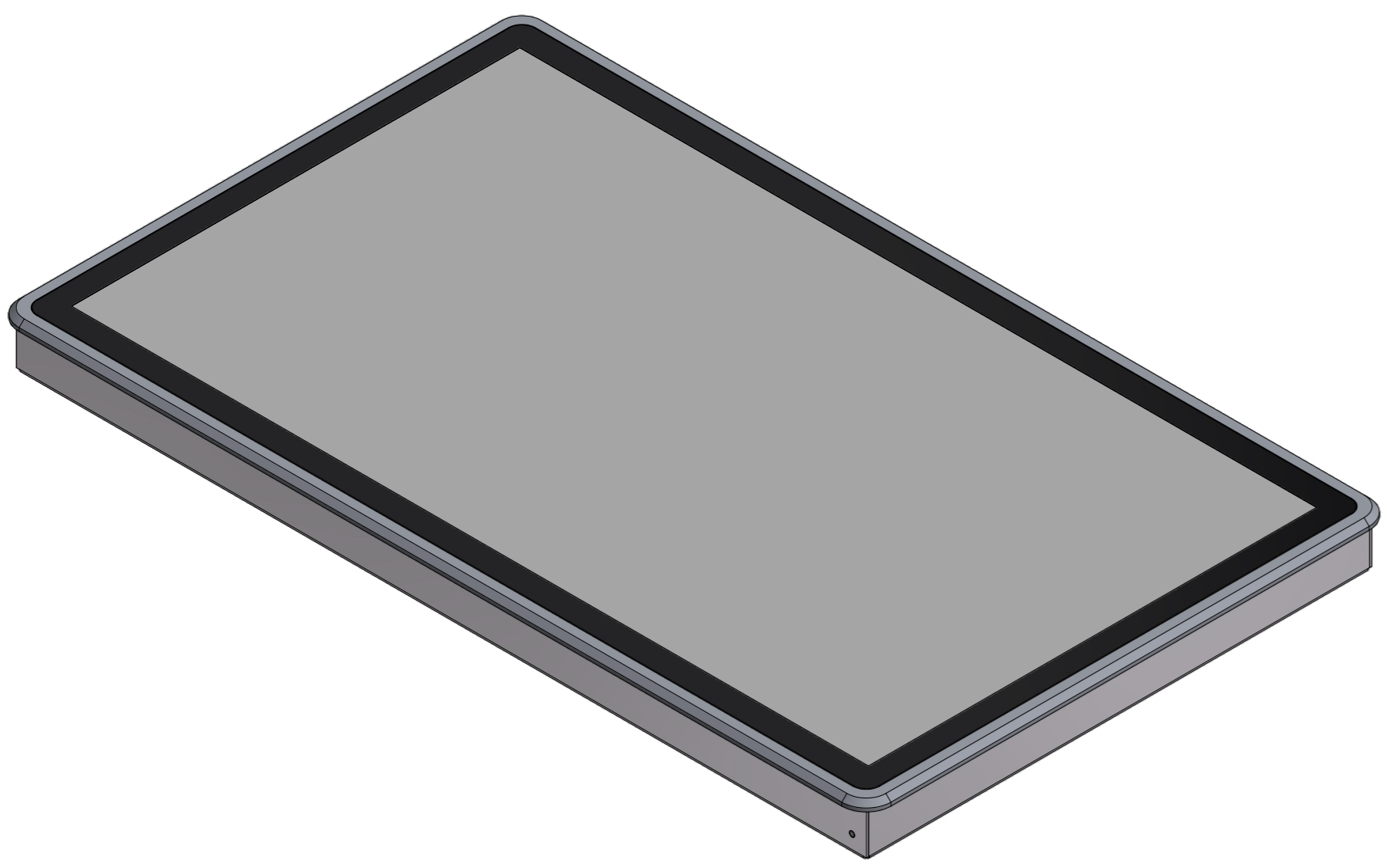
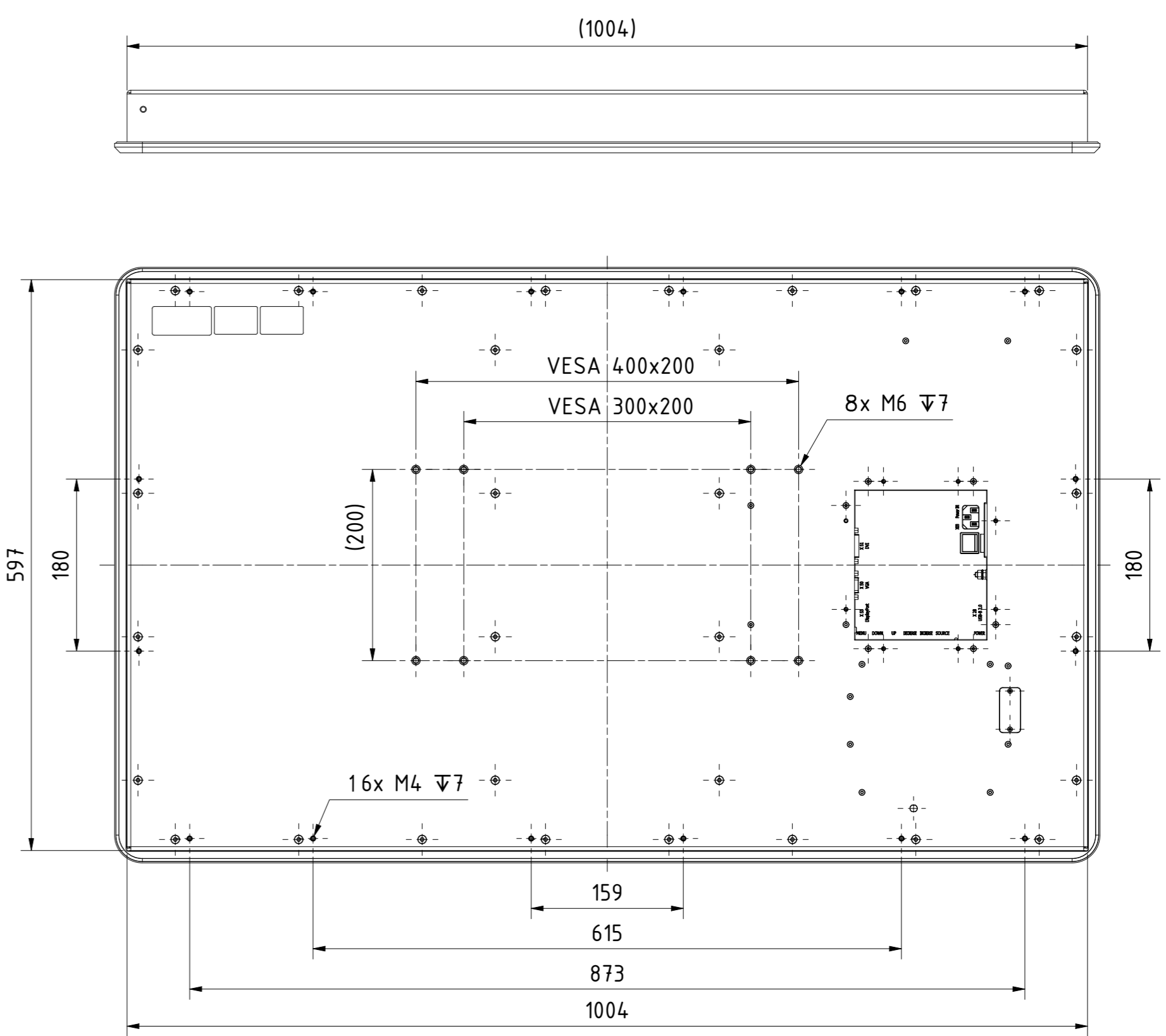
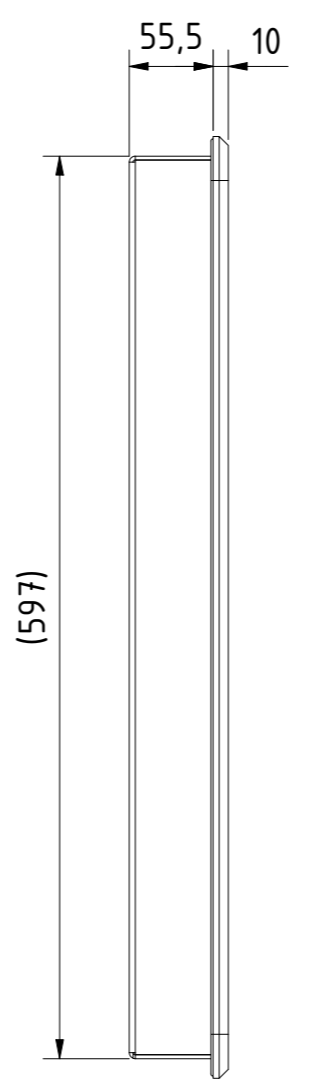
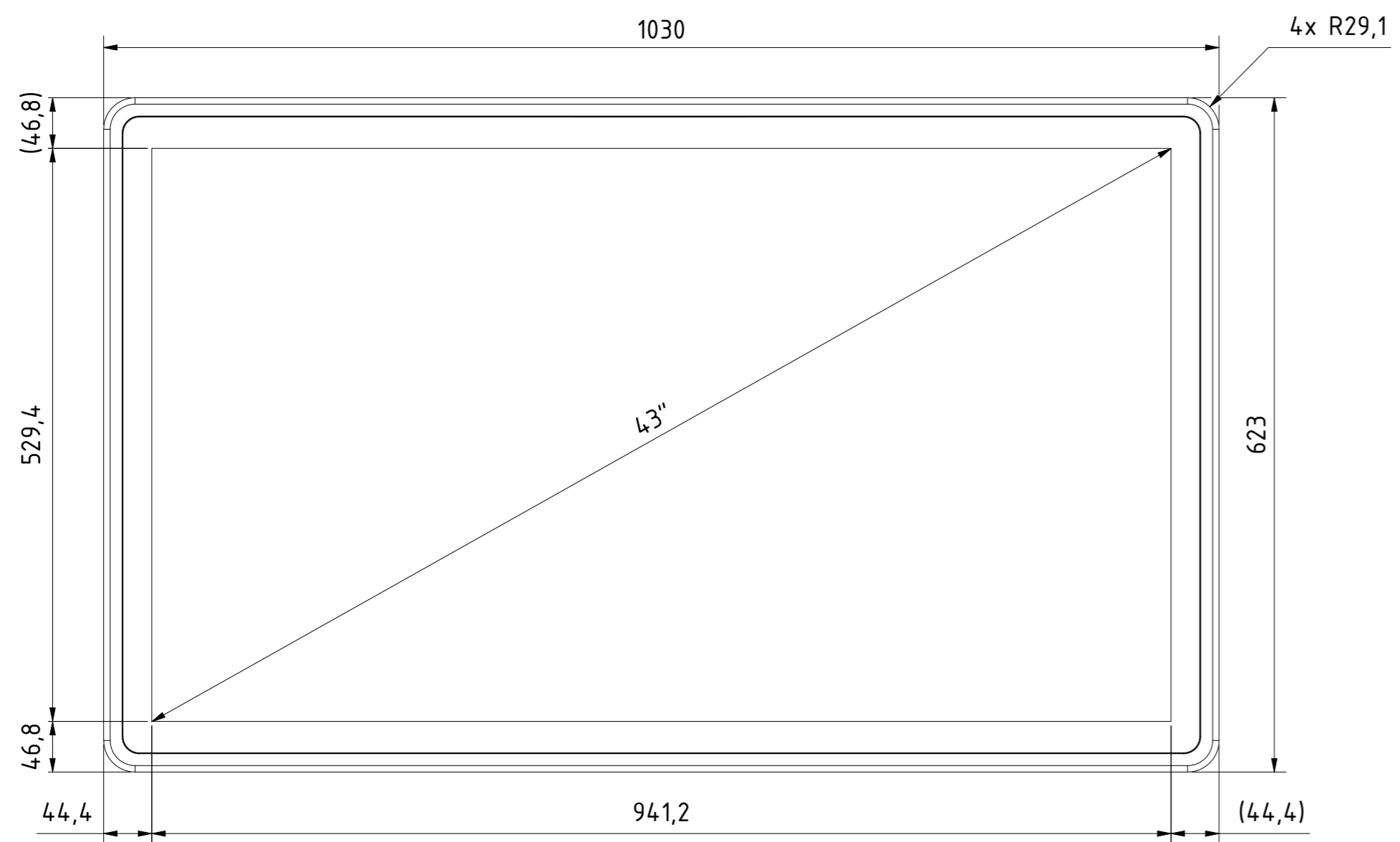

Tolerierung [Tolerancing] ISO 8015		alle Maße in mm [all dimensions in mm]		Maßstab [Scale] 1 : 5		DIN A2	
E-Mail: info@trsystems.de		CAD: STEP		Bezeichnung [Designation]:			
				_notion.D.terminal 43 fullHD			
				Zeichnung-Nr. [Drawing-No.]:			
				778-42990			
				Dok.Art. IDW			
				Teil-Dok. 000			
				Dok.-Vs. 00			
				1/4 Bl.			
Zust.	Änderungen	Datum	Name	 TRsystems GmbH Englishalder 16 D-78647 Trossingen Tel. +49 7425 228-0 www.trsystems.de			

i Alle nicht tolerierten Maße sind Richtwerte. [All non-tolerated dimensions are guide values.]
 Technische Änderungen grundsätzlich vorbehalten. [We reserve the right to make technical changes.]

Option: BG Montage-Kit Einbau (778-90077)

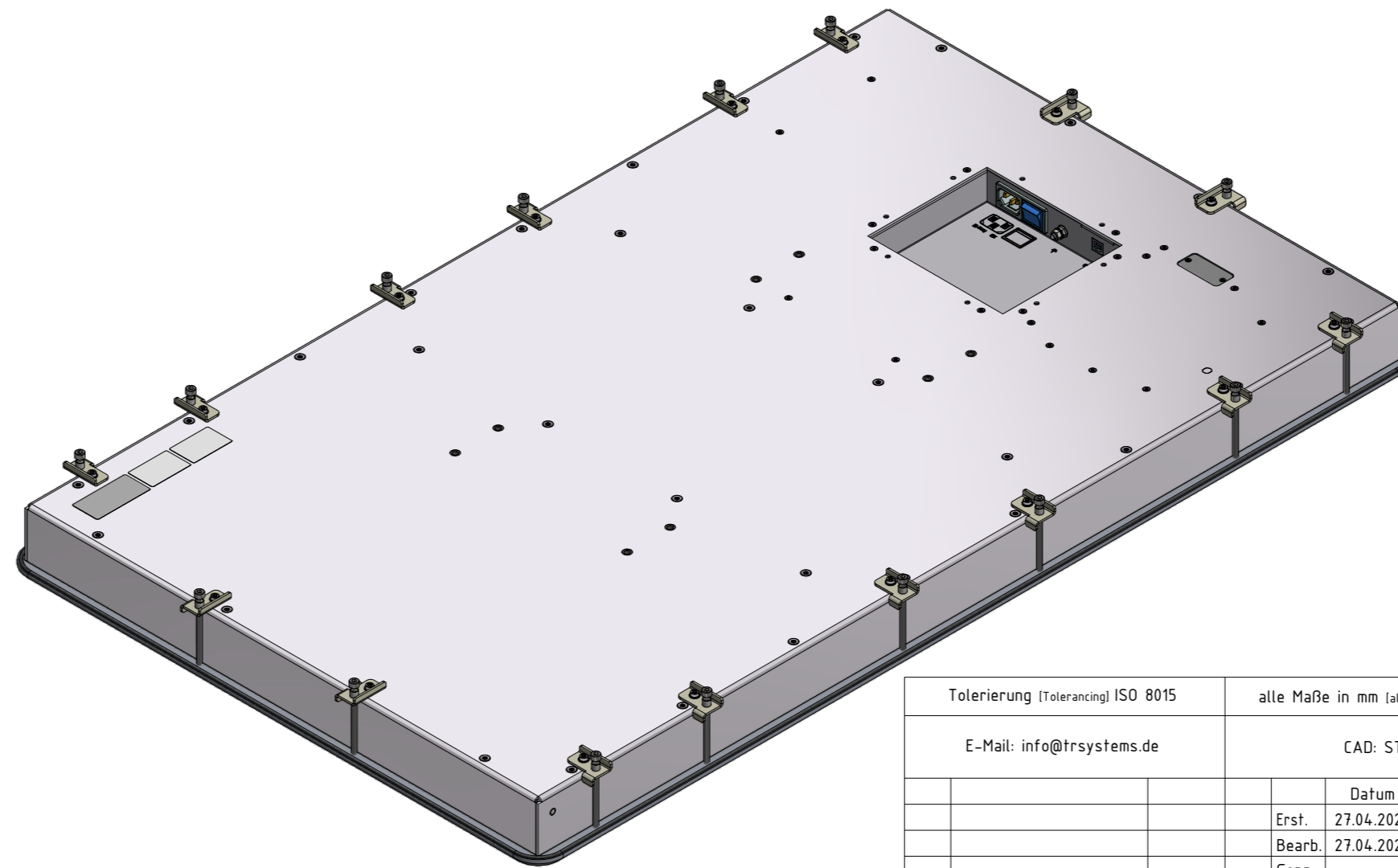
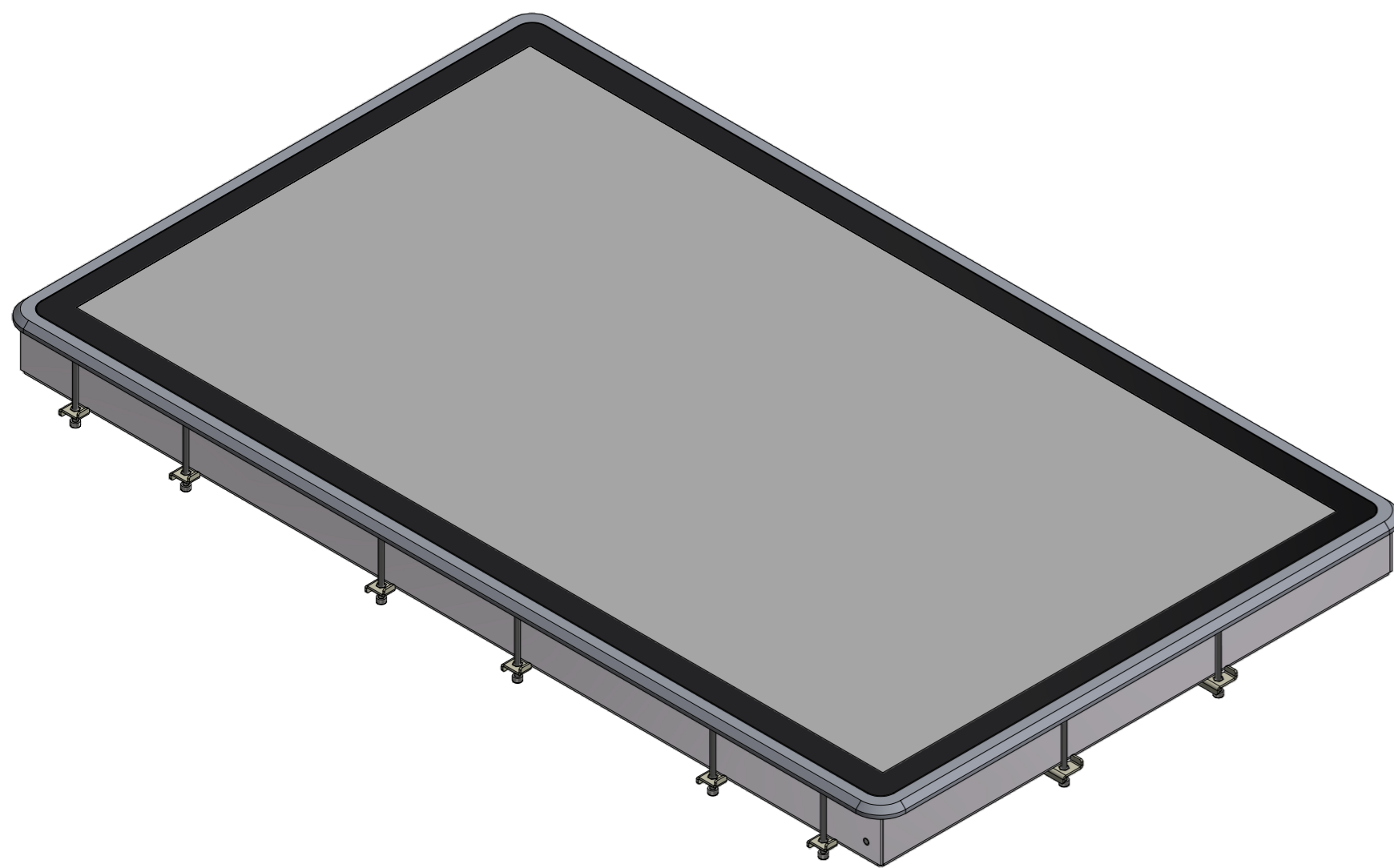
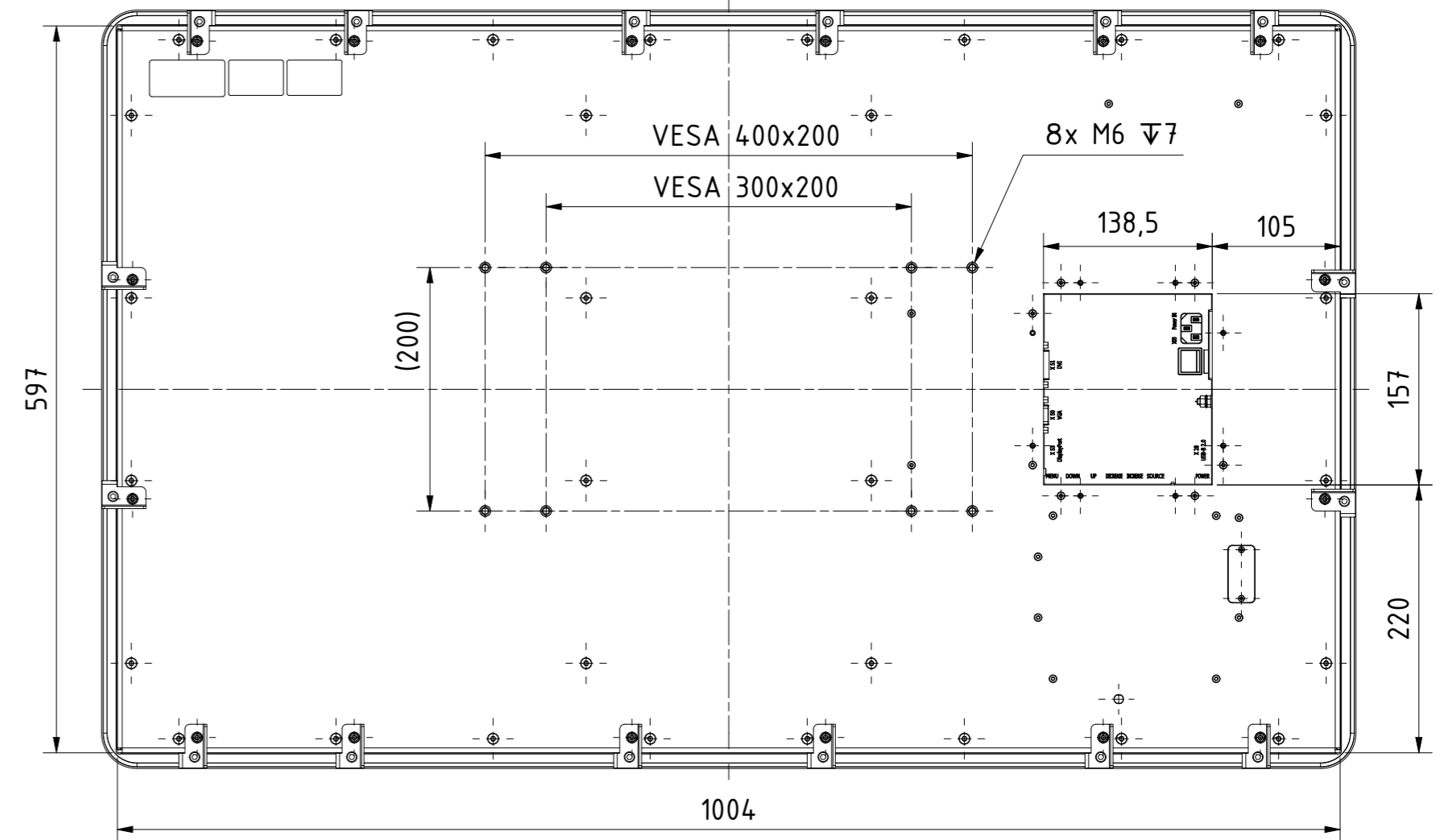
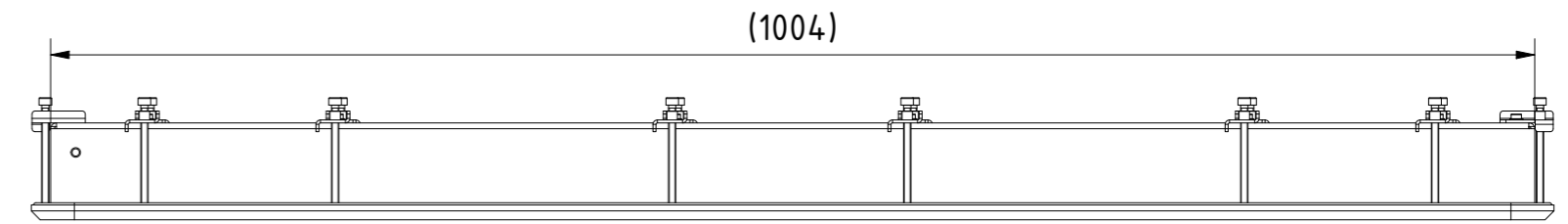
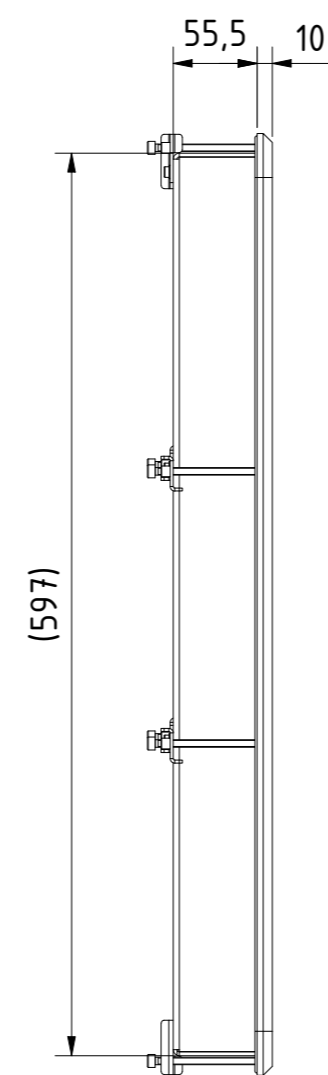
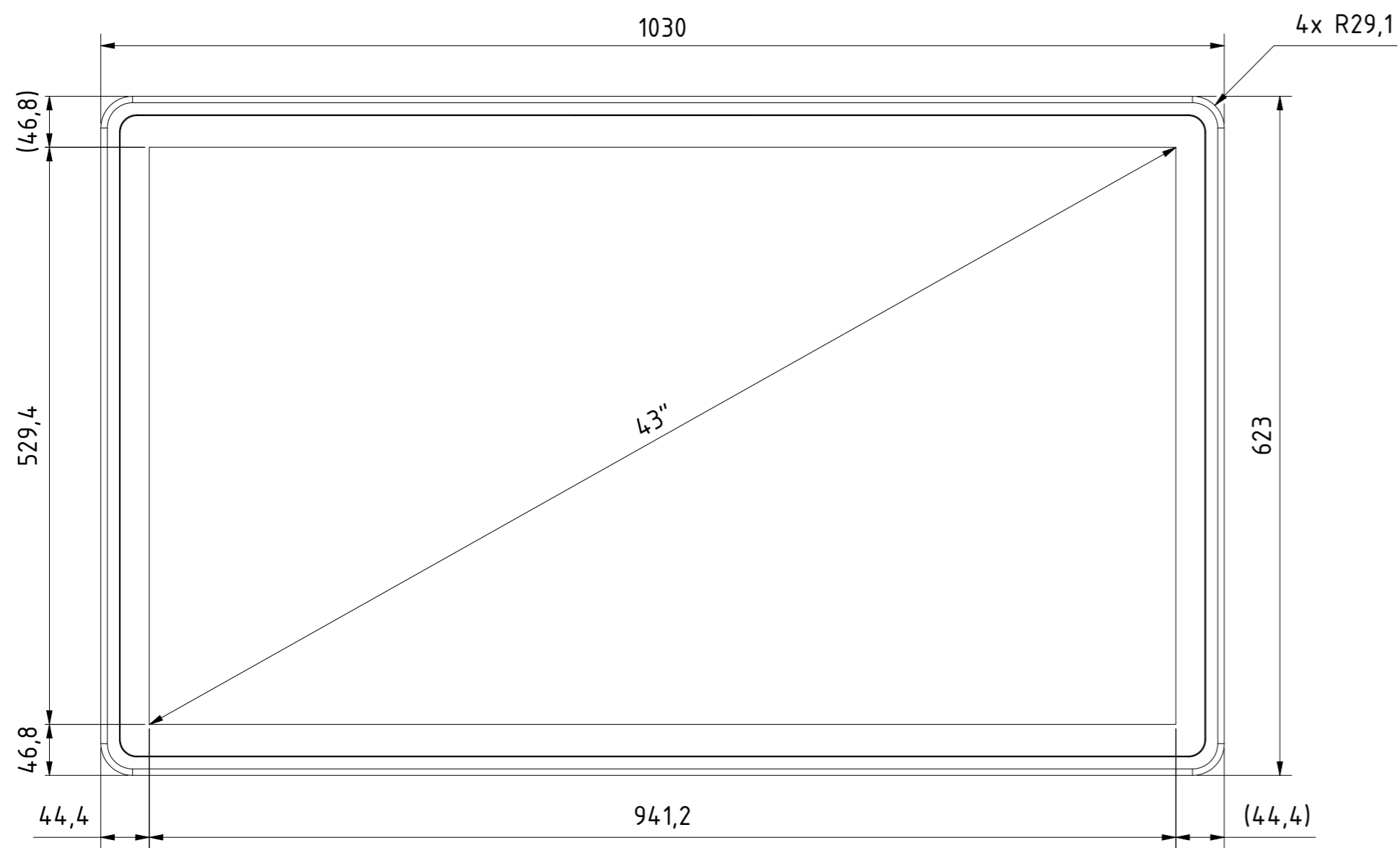
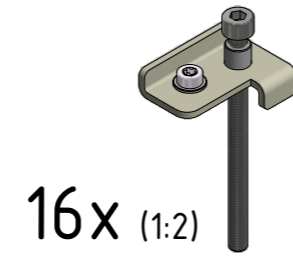

Tolerierung [Tolerancing] ISO 8015		alle Maße in mm [all dimensions in mm]		Maßstab [Scale] 1 : 5		DIN A2	
E-Mail: info@trsystems.de		CAD: STEP		Bezeichnung [Designation]:			
				_notion.D.terminal 43 fullHD			
		Datum		Name		Zeichnung-Nr. [Drawing-No.]:	
		Erst. 27.04.2023		AIPLE		778-42990	
		Bearb. 27.04.2023		AIPLE		Dok.-Art. IDW	
		Gepr.				Teil-Dok. 000	
		Norm				Dok.-Vs. 00	
						2/4 Bl.	
Zust. Änderungen		Datum		Name		www.trsystems.de	



i Alle nicht tolerierten Maße sind Richtwerte. [All non-tolerated dimensions are guide values.]
 Technische Änderungen grundsätzlich vorbehalten. [We reserve the right to make technical changes.]

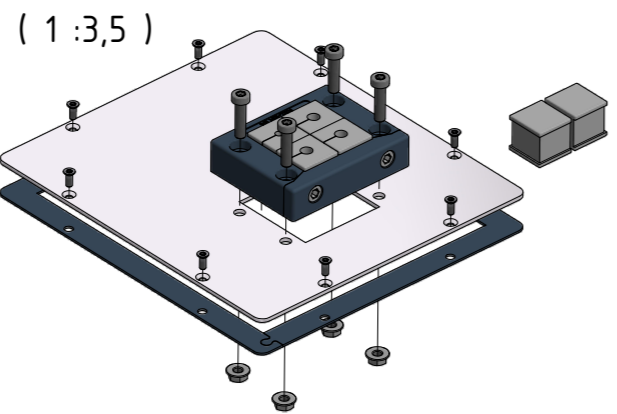

Option: IP54-Kit (778-90182)

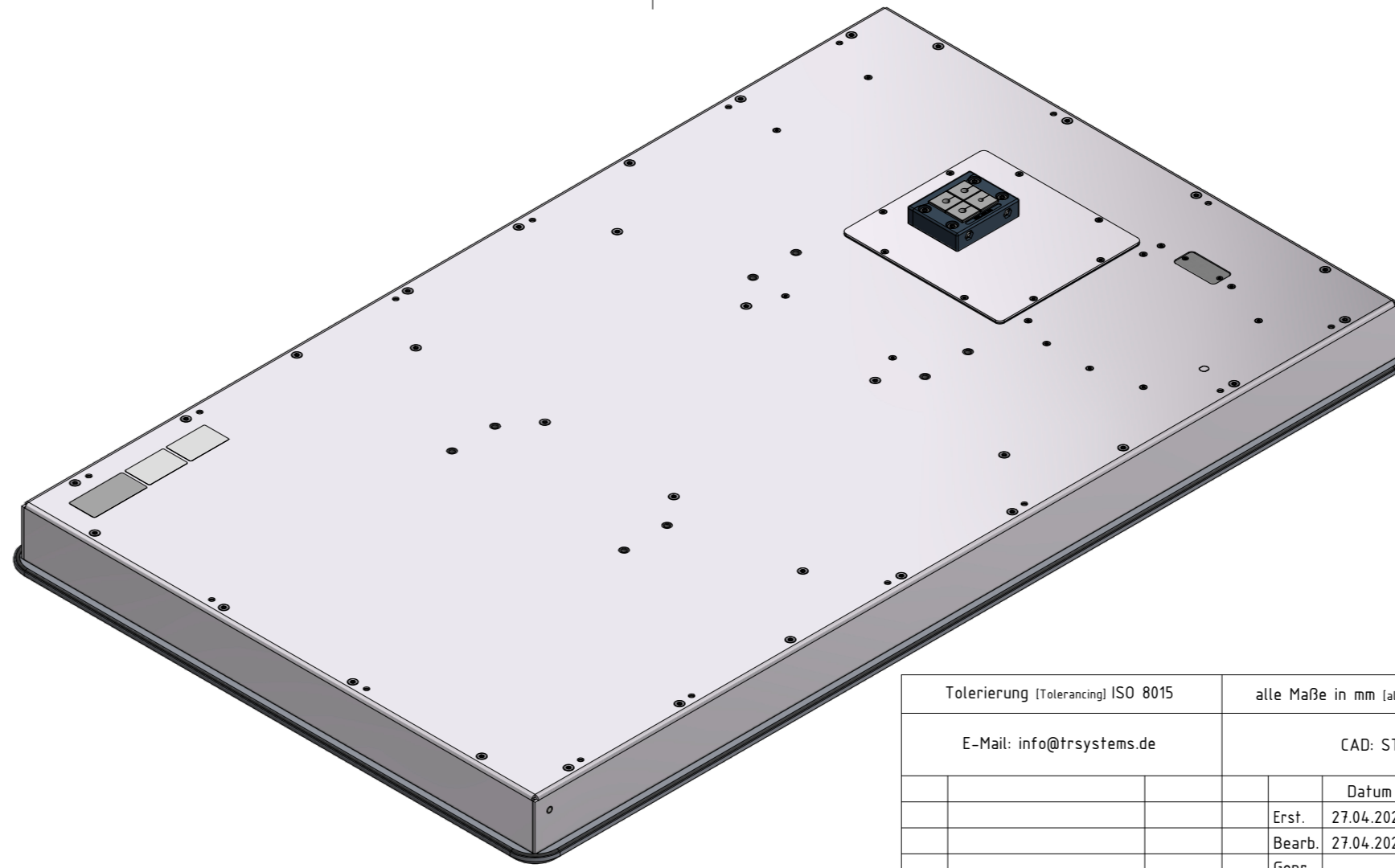
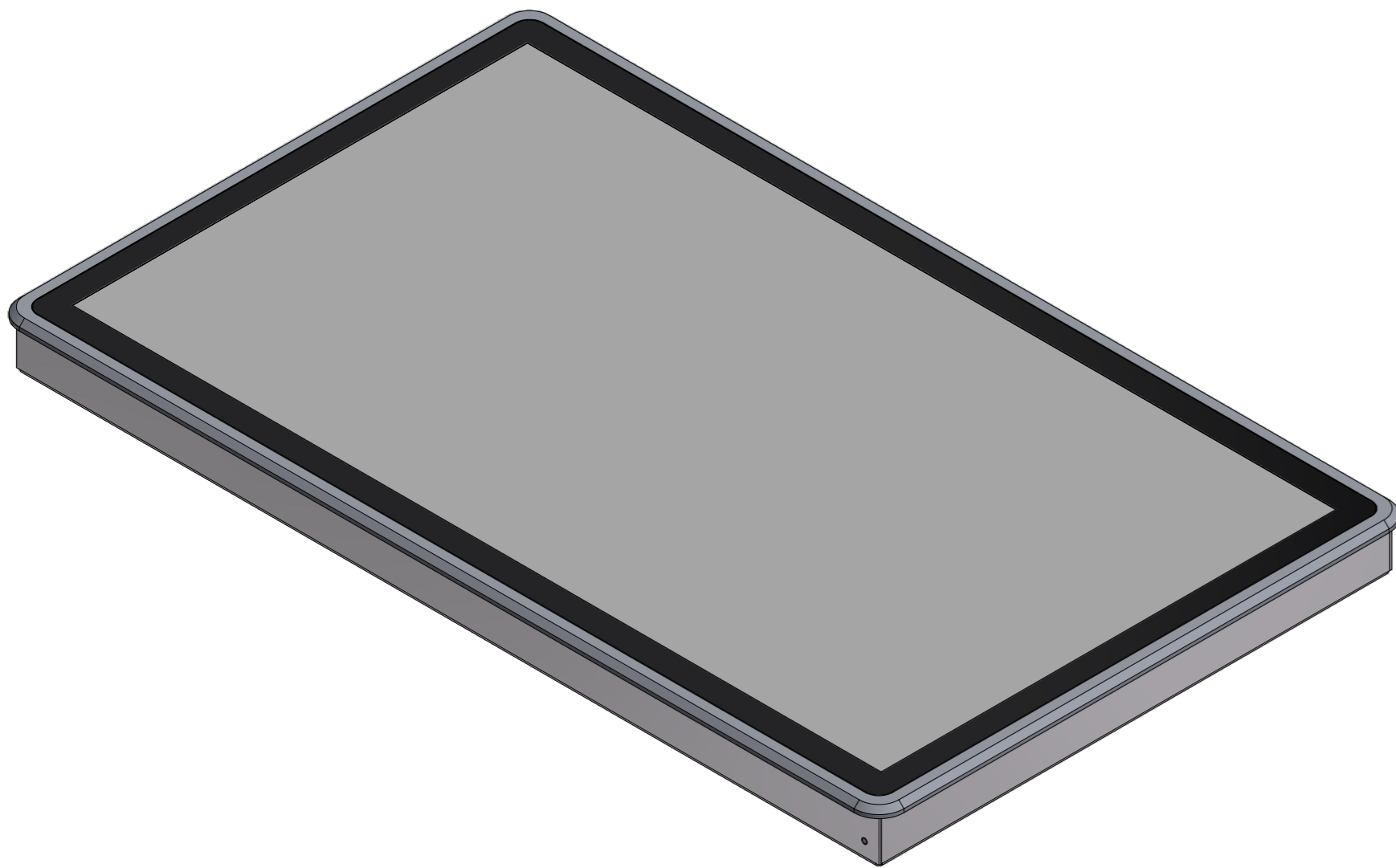
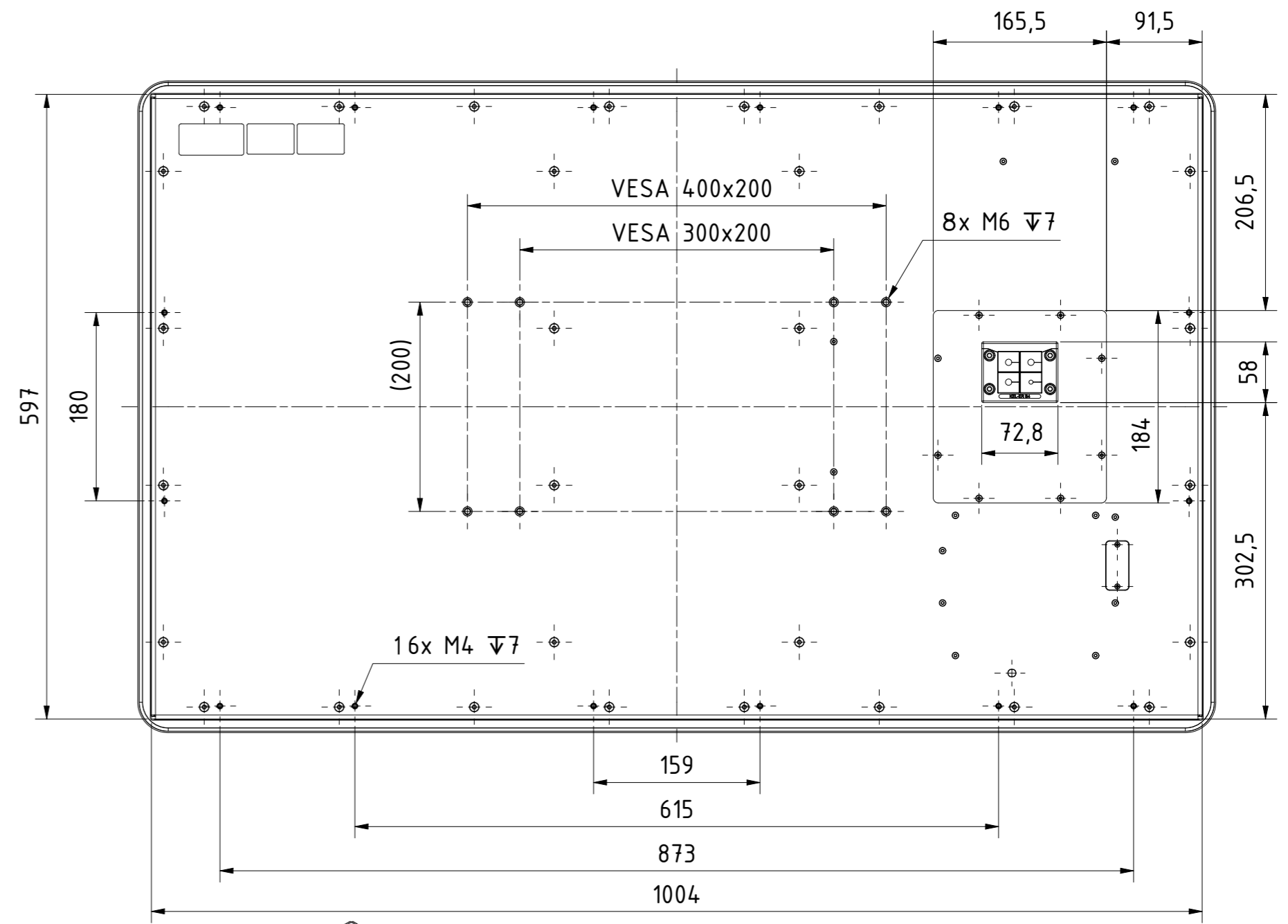
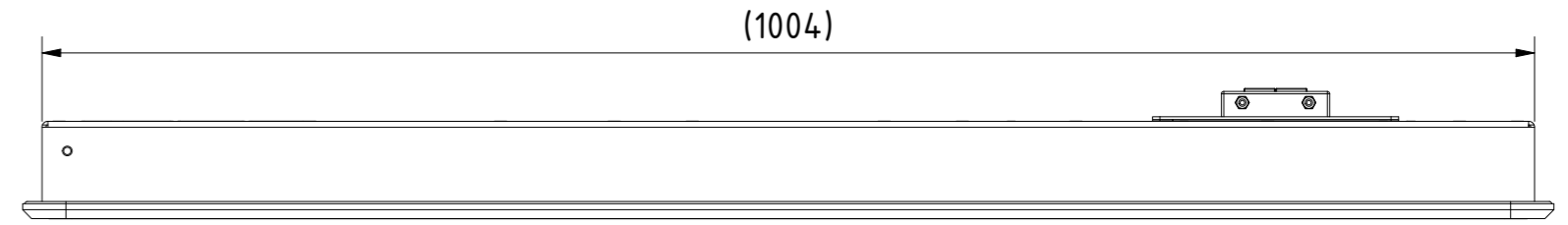
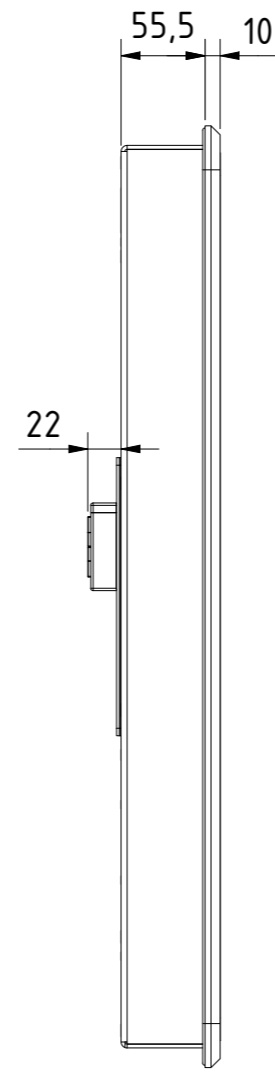
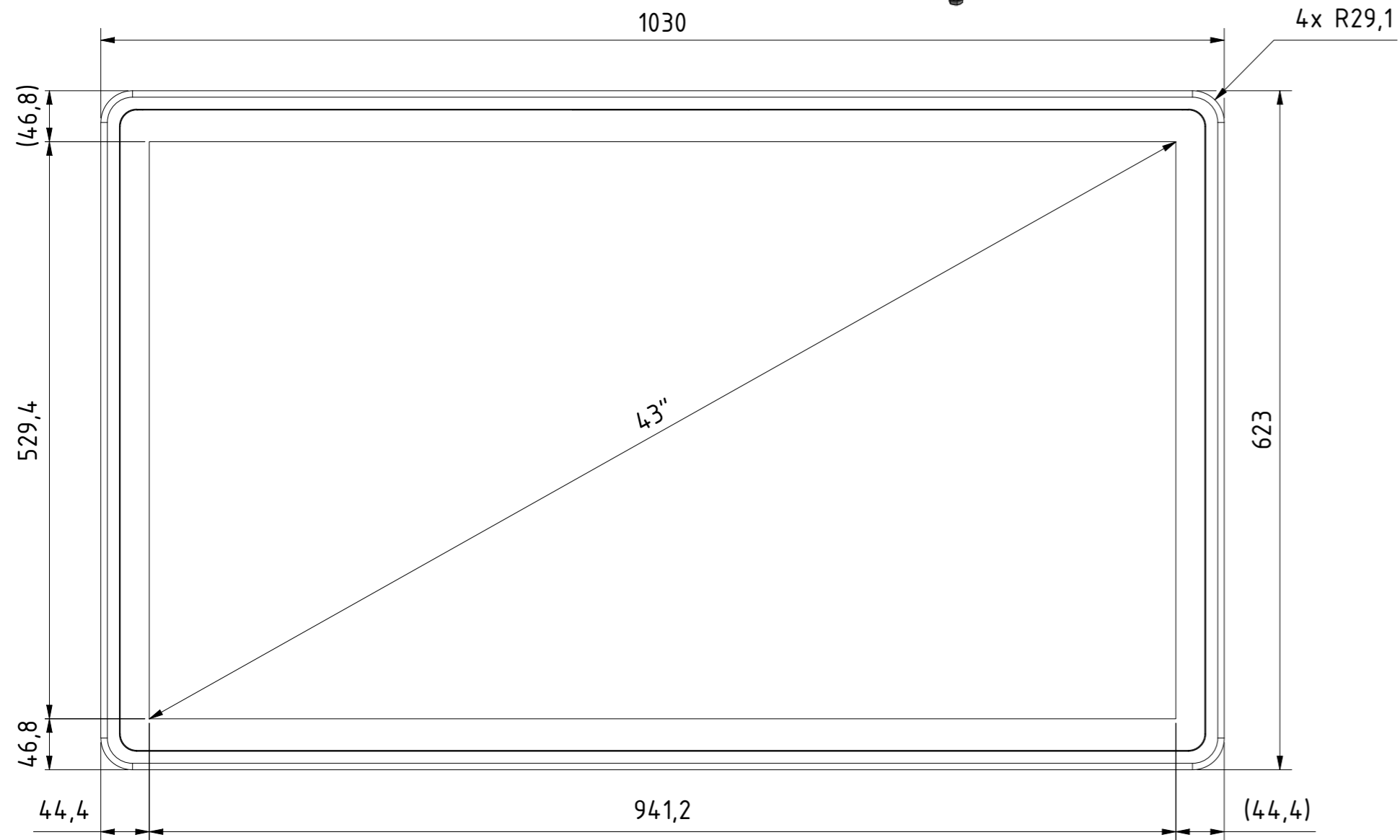

Tolerierung [Tolerancing] ISO 8015		alle Maße in mm [all dimensions in mm]		Maßstab [Scale] 1 : 5		DIN A2	
E-Mail: info@trsystems.de		CAD: STEP		Bezeichnung [Designation]:			
				_notion.D.terminal 43 fullHD			
		Datum		Name		Zeichnung-Nr. [Drawing-No.]:	
		Erst. 27.04.2023		AIPLE		778-42990	
		Bearb. 27.04.2023		AIPLE		Dok.-Nr. IDW	
		Gepr.				Teil-Dok. 000	
		Norm				Dok.-Vs. 00	
						3/4 Bl.	
Zust.		Änderungen		Datum		Name	





Alle nicht tolerierten Maße sind Richtwerte. [All non-tolerated dimensions are guide values.]
 Technische Änderungen grundsätzlich vorbehalten. [We reserve the right to make technical changes.]

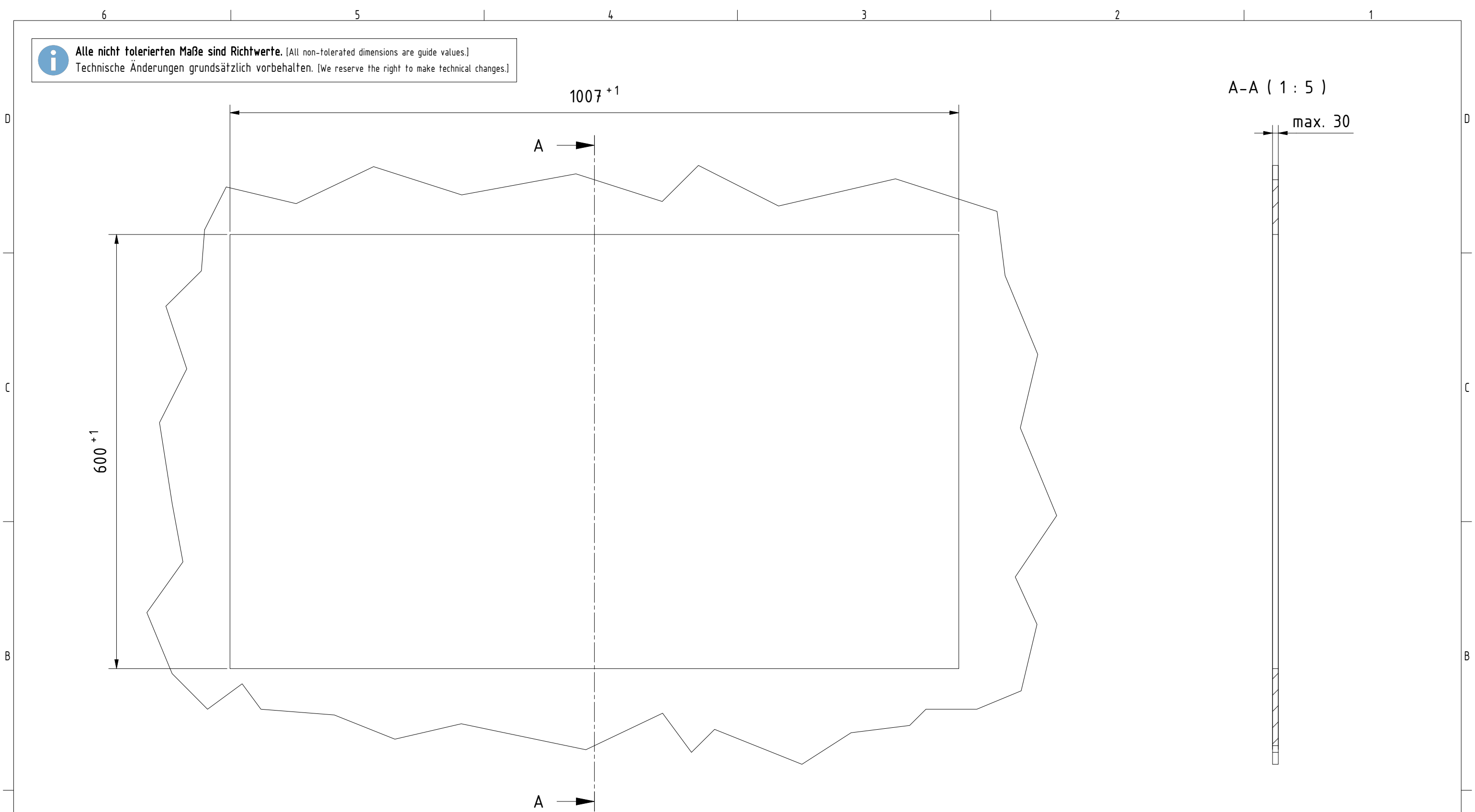

Tolerierung [Tolerancing] ISO 8015		alle Maße in mm [all dimensions in mm]		Maßstab [Scale] 1 : 5		DIN A3	
E-Mail: info@trsystems.de				CAD: STEP			
		Datum	Name	Bezeichnung [Designation]: _notion.D.terminal 43 fullHD Montageausschnitt			
		Erst.	27.04.2023 AIPLE				
		Bearb.	27.04.2023 AIPLE				
		Gepr.					
		Norm					
		TRsystems GmbH Eglshalde 16 D-78647 Trossingen Tel. +49 7425 228-0 www.trsystems.de		Zeichnung-Nr. [Drawing-No.]: 778-42990			
Zust.	Änderungen	Datum	Name	Dok.Art. IDW	Teil-Dok. 000	Dok.Vs. 00	4/4 Bl.